

Caution: This document contains mixed page sizes (8.5 x 11 or 11 x 17), which may affect printing. Please adjust your printer settings according to the size of each page you wish to print.



Redistribution or publication of this document by any means, is strictly prohibited.



Installation Manual

EK-EM GENERATOR SET

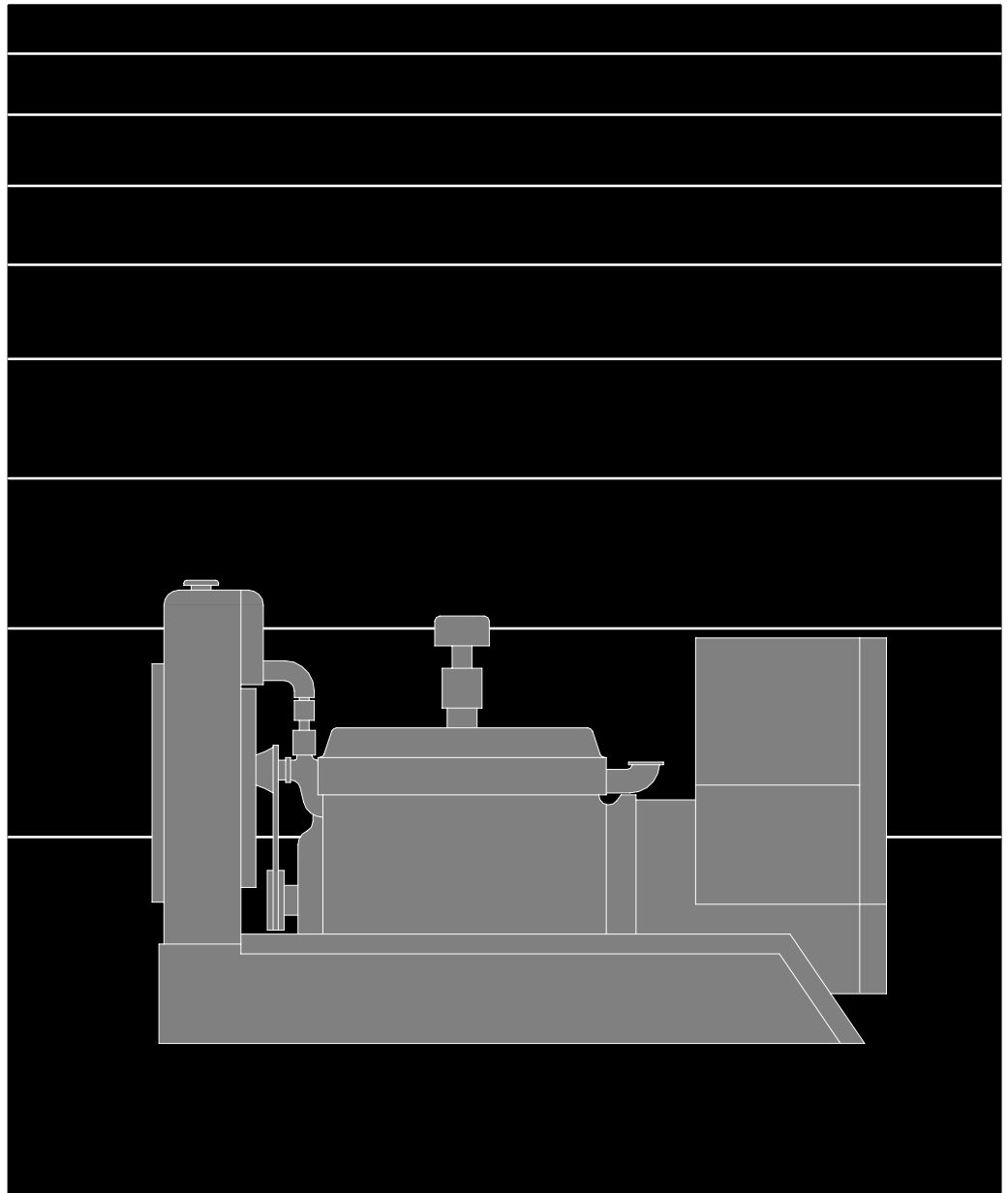

Printed U.S.A.

928-0602 12-95

Table of Contents

SECTION	TITLE	PAGE
	SAFETY PRECAUTIONS	ii
1	INTRODUCTION	1-1
	About this Manual	1-1
	Installation Overview	1-1
2	SPECIFICATIONS	2-1
3	MOUNTING THE GENERATOR SET	3-1
	General	3-1
	Location	3-1
	Mounting	3-2
	Access to Set	3-2
4	MECHANICAL CONNECTIONS	4-1
	General	4-1
	Fuel System	4-1
	Exhaust System	4-2
	Ventilation and Cooling	4-3
5	ELECTRICAL CONNECTIONS	5-1
	General	5-1
	Transfer Switch	5-1
	AC Wiring	5-2
	Control Wiring	5-3
	Engine Control Monitor Board (A11)	5-4
	Auxiliary Relay Board (Optional)	5-6
	Time-Delay Module (A15)	5-8

⚠ WARNING: ⚠

The engine exhaust from this product contains chemicals known to the State of California to cause cancer, birth defects or other reproductive harm.

SECTION	TITLE	PAGE
6	PRESTART PREPARATIONS	6-1
	General	6-1
	Lubrication	6-1
	Coolant	6-1
	Fuel	6-1
	Ventilation	6-1
	Exhaust System	6-1
	Electrical System	6-1
	Mechanical Checks	6-1
7	INITIAL START AND CHECKS	7-1
	Starting	7-1
	Engine Gauges	7-1
	AC Meters (If Equipped)	7-1
	Engine Monitor Indicator Lamps	7-1
	Exhaust System	7-2
	Fuel System	7-2
	DC Electrical System	7-2
	Cooling System	7-2
	Mechanical Adjustments	7-2
8	INSTALLATION CHECKLIST	8-1
	General	8-1
	Genset Support	8-1
	Cooling Air Flow	8-1
	Fuel System	8-1
	Exhaust System	8-2
	AC and DC Wiring	8-2
	Genset Prestart	8-2
9	WIRING DIAGRAMS	9-1

Safety Precautions

Before operating the generator set, read the Operator's Manual and become familiar with it and the equipment. **Safe and efficient operation can be achieved only if the equipment is properly operated and maintained.** Many accidents are caused by failure to follow fundamental rules and precautions.

The following symbols, found throughout this manual, alert you to potentially dangerous conditions to the operator, service personnel, or the equipment.

⚠ DANGER *This symbol warns of immediate hazards which will result in severe personal injury or death.*

⚠ WARNING *This symbol refers to a hazard or unsafe practice which can result in severe personal injury or death.*

⚠ CAUTION *This symbol refers to a hazard or unsafe practice which can result in personal injury or product or property damage.*

FUEL AND FUMES ARE FLAMMABLE

Fire, explosion, and personal injury or death can result from improper practices.

- DO NOT fill fuel tanks while engine is running, unless tanks are outside the engine compartment. Fuel contact with hot engine or exhaust is a potential fire hazard.
- DO NOT permit any flame, cigarette, pilot light, spark, arcing equipment, or other ignition source near the generator set or fuel tank.
- Fuel lines must be adequately secured and free of leaks. Fuel connection at the engine should be made with an approved flexible line. Do not use copper piping on flexible lines as copper will become brittle if continuously vibrated or repeatedly bent.
- Be sure all fuel supplies have a positive shutoff valve.

- Be sure battery area has been well-ventilated prior to servicing near it. Lead-acid batteries emit a highly explosive hydrogen gas that can be ignited by arcing, sparking, smoking, etc..

EXHAUST GASES ARE DEADLY

- Provide an adequate exhaust system to properly expel discharged gases away from enclosed or sheltered areas and areas where individuals are likely to congregate. Visually and audibly inspect the exhaust daily for leaks per the maintenance schedule. Make sure that exhaust manifolds are secured and not warped. Do not use exhaust gases to heat a compartment.
- Be sure the unit is well ventilated.
- Engine exhaust and some of its constituents are known to the state of California to cause cancer, birth defects, and other reproductive harm.

MOVING PARTS CAN CAUSE SEVERE PERSONAL INJURY OR DEATH

- Keep your hands, clothing, and jewelry away from moving parts.
- Before starting work on the generator set, disconnect battery charger from its AC source, then disconnect starting batteries, negative (-) cable first. This will prevent accidental starting.
- Make sure that fasteners on the generator set are secure. Tighten supports and clamps, keep guards in position over fans, drive belts, etc.
- Do not wear loose clothing or jewelry in the vicinity of moving parts, or while working on electrical equipment. Loose clothing and jewelry can become caught in moving parts. Jewelry can short out electrical contacts and cause shock or burning.
- If adjustment must be made while the unit is running, use extreme caution around hot manifolds, moving parts, etc.

ELECTRICAL SHOCK CAN CAUSE SEVERE PERSONAL INJURY OR DEATH

- Remove electric power before removing protective shields or touching electrical equipment. Use rubber insulative mats placed on dry wood platforms over floors that are metal or concrete when around electrical equipment. Do not wear damp clothing (particularly wet shoes) or allow skin surface to be damp when handling electrical equipment.
- Use extreme caution when working on electrical components. High voltages can cause injury or death. DO NOT tamper with interlocks.
- Follow all applicable state and local electrical codes. Have all electrical installations performed by a qualified licensed electrician. Tag and lock open switches to avoid accidental closure.
- DO NOT CONNECT GENERATOR SET DIRECTLY TO ANY BUILDING ELECTRICAL SYSTEM. Hazardous voltages can flow from the generator set into the utility line. This creates a potential for electrocution or property damage. Connect only through an approved isolation switch or an approved paralleling device.

HIGH VOLTAGE GENERATOR SETS (1.9kV to 15kV)

- High voltage acts differently than low voltage. Special equipment and training is required to work on or around high voltage equipment. Operation and maintenance must be done only by persons trained and qualified to work on such devices. Improper use or procedures will result in severe personal injury or death.
- Do not work on energized equipment. Unauthorized personnel must not be permitted near energized equipment. Due to the nature of high voltage electrical equipment, induced voltage remains even after the equipment is disconnected from the power source. Plan the time for maintenance with authorized personnel so that the equipment can be de-energized and safely grounded.

GENERAL SAFETY PRECAUTIONS

- Coolants under pressure have a higher boiling point than water. DO NOT open a radiator or heat exchanger pressure cap while the engine is running. Allow the generator set to cool and bleed the system pressure first.
- Benzene and lead, found in some gasoline, have been identified by some state and federal agencies as causing cancer or reproductive toxicity. When checking, draining or adding gasoline, take care not to ingest, breathe the fumes, or contact gasoline.
- Used engine oils have been identified by some state or federal agencies as causing cancer or reproductive toxicity. When checking or changing engine oil, take care not to ingest, breathe the fumes, or contact used oil.
- Provide appropriate fire extinguishers and install them in convenient locations. Consult the local fire department for the correct type of extinguisher to use. Do not use foam on electrical fires. Use extinguishers rated ABC by NFPA.
- Make sure that rags are not left on or near the engine.
- Remove all unnecessary grease and oil from the unit. Accumulated grease and oil can cause overheating and engine damage which present a potential fire hazard.
- Keep the generator set and the surrounding area clean and free from obstructions. Remove any debris from the set and keep the floor clean and dry.
- Do not work on this equipment when mentally or physically fatigued, or after consuming any alcohol or drug that makes the operation of equipment unsafe.
- Substances in exhaust gases have been identified by some state or federal agencies as causing cancer or reproductive toxicity. Take care not to breath or ingest or come into contact with exhaust gases.

KEEP THIS MANUAL NEAR THE GENSET FOR EASY REFERENCE

1. Introduction

ABOUT THIS MANUAL

This manual provides installation instructions for the EK / EM Series generator sets. This includes the following information:

Mounting Recommendations – Instructions for fastening generator set to base and space requirements for normal operation and service.

Mechanical Connections – Location of connection points for fuel, exhaust, ventilation, and cooling.

Electrical Connections – Location of electrical connection points for the control, generator, and starting system.

Prestart – Checklist of items or procedures needed to prepare generator set for operation.

Initial Startup – Test complete system to make sure of proper installation, satisfactory performance, and safe operation. Refer to Operators Manual for troubleshooting information.

Installation Checklist – Reference checks upon completion of installation.

This manual DOES NOT provide application information for selecting a generator set or designing the complete installation. If it is necessary to design the various integrated systems (fuel, exhaust, cooling, etc.), review standard installation practices, or specify system materials, additional information is required. For engineering data specific to the generator set, refer to the specification and product data sheets. For application information, refer to Application Manual T-030, “Liquid Cooled Generator Sets”.

INSTALLATION OVERVIEW

These installation recommendations apply to typical installations with standard model generator sets. Whenever possible, these recommendations also cover factory designed options or modifications. However, because of the many variables in any installation, it is not possible to provide specific recommendations for every situation. If there are any questions not answered by this manual, contact your nearest Cummins/Onan dealer or distributor for assistance .

Application and Installation

A standby power system must be carefully planned and correctly installed for proper operation. This involves two essential elements: application and installation.

Application (as it applies to generator set installations) refers to the design of the complete standby power system that usually includes power distribution equipment, transfer switches, ventilation equipment, mounting pads, and cooling, exhaust, and fuel systems. Each component must be correctly designed so the complete system will function as intended. Application and design is an engineering function generally done by specifying engineers or other trained specialists. Specifying engineers are responsible for the design of the complete standby system and for selecting the materials and products required.

Installation refers to the actual setup and assembly of the standby power system. The installers set up and connect the various components of the system as specified in the system design plan. The complexity of the standby system normally requires the special skills of qualified electricians, plumbers, sheetmetal workers, etc. to complete the various segments of the installation. This is necessary so all components are assembled using standard methods and practices.

Safety Considerations

The generator set has been carefully designed to provide safe and efficient service when properly installed, maintained, and operated. However, the overall safety and reliability of the complete system is dependent on many factors outside the control of the generator set manufacturer. To avoid possible safety hazards, make all mechanical and electrical connections to the generator set exactly as specified in this manual. All systems external to the generator (fuel, exhaust, electrical, etc.) must comply with all applicable codes. Make certain all required inspections and tests have been completed and all code requirements have been satisfied before certifying the installation is complete and ready for service.

2. Specifications

MODEL	EK	EM
Engine Onan Modified Ford In-line 6	CSG-649	CSG-649
Fuel System Inlet Size Natural Gas Propane Vapor Propane Liquid Gasoline	3/4 inch NPT 3/4 inch NPT 1/4 inch NPT 1/8 inch NPT	3/4 inch NPT 3/4 inch NPT 1/4 inch NPT 1/8 inch NPT
Exhaust Connection Backpressure (Max. Allowed)	2 inch NPT 20.4 inch H ₂ O	2 inch NPT 20.4 inch H ₂ O
Electrical System Starting Voltage Battery Charging Current	12V 65 amp	12V 65 amp
Cooling System Coolant Capacity with Standard Radiator	5 gal (19 L)	5 gal (19 L)
Lubricating System Oil Capacity with Filter	7 qt (7 L)	7 qt (7 L)
Battery Required Battery Voltage SAE Number	12 VDC 60	12 VDC 60

IMPORTANT!

DEPENDING ON YOUR LOCATION AND INTENDED USE, FEDERAL, STATE OR LOCAL LAWS AND REGULATIONS MAY REQUIRE YOU TO OBTAIN AN AIR QUALITY EMISSIONS PERMIT BEFORE BEGINNING INSTALLATION OF YOUR GENERATOR SET. BE SURE TO CONSULT WITH LOCAL POLLUTION CONTROL OR AIR QUALITY AUTHORITIES BEFORE COMPLETING YOUR CONSTRUCTION PLANS.

3. Mounting the Generator Set

GENERAL

Most generator set installations must be engineered so the generator set will function properly under the expected load conditions. Use these instructions as a general guide only. Follow the instructions of the consulting engineer when locating or installing any components. The complete installation must comply with all local and state building codes, fire ordinances, and other applicable regulations. Refer to Onan Application Manual, T-030 , for further installation information.

Requirements to be considered prior to installation:

- Level mounting surface
- Adequate cooling air
- Adequate fresh induction air

- Discharge of circulated air
- Discharge of exhaust gases
- Electrical connections
- Accessibility for operation and servicing
- Noise levels
- Vibration isolation

LOCATION

Generator set location is decided mainly by related systems such as ventilation, wiring, fuel, and exhaust. The set should be located as near as possible to the main power fuse box.

Provide a location away from extreme ambient temperatures and protect the generator set from adverse weather conditions. An optional housing is available for outside operation.

MOUNTING

Generator sets are mounted on a steel skid that provides proper support. The engine-generator assembly is isolated from the skid frame by rubber mounts that provide adequate vibration isolation for normal installations. For critical installations, install vibration isolators between the skid base and foundation.

Mount the generator set on a substantial and level base such as a concrete pad.

Use 3/4-inch diameter, anchored mounting bolts to secure the generator set skid to the floor to prevent movement. Secure the skid using a flat washer and hex nut for each bolt (Figure 3-1). For proper spacing of mounting bolts and set mounting dimensions, see your generator set outline drawing.

ACCESS TO SET

Plan for access to the generator set for servicing and provide adequate lighting around the unit. For convenience in general servicing such as the radiator, fan belt and changing the crankcase oil, the surface of the mounting base should be at least 6 inches (152 mm) above the floor.

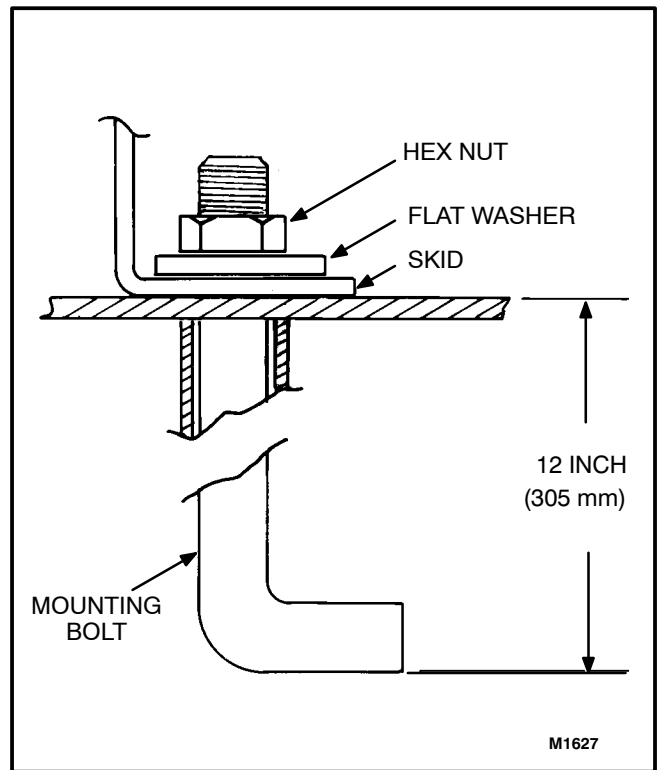

FIGURE 3-1 BOLT DIAGRAM

4. Mechanical Connections

GENERAL

The generator set mechanical system installation includes connecting the fuel, exhaust, ventilation and cooling systems. Before starting any type of fuel installation, all pertinent state and local codes must be complied with and the installation must be inspected before the unit is put in service.

FUEL SYSTEM

Sets can be equipped to operate on gasoline only, LPG (propane), gasoline/natural gas, gasoline/LPG and LPG/natural gas combinations. A fuel selector switch may be provided for fuel changeover. (The position of the switch determines which fuel valve will open when the set is operated.)

Gasoline Fuel

⚠WARNING *Fuel presents the hazard of fire or explosion which can result in severe personal injury or death. Do not smoke or allow any flame, spark, pilot light, arc-producing equipment, or switch, or other ignition sources around fuel or fuel components, or in the installation area or areas with shared ventilation. Keep a type ABC fire extinguisher nearby.*

The gasoline-carbureted fuel system delivers a mixture of fuel and air to the combustion chamber. The system draws fuel from a tank, delivers it through a filter and fuel pump, to the carburetor float chamber. Air passing through the carburetor venturi draws fuel from the the float chamber.

See *Specifications* section for gasoline inlet size. Fuel lift should not exceed 6 feet (1.83 m). The recommendations in Onan publication T030, the Application Manual for *Liquid-Cooled Generator Sets*, should be followed in regard to fuel supply system pipe sizes and manual shutoff valves.

Natural Gas/LPG Vapor/LPG Liquid Fuel System

⚠WARNING *Natural gas and LPG vapor are highly flammable. LPG vapor is heavier than air. Do not bleed lines so fumes can collect in low areas. Do not smoke or allow any flame, spark, arcing switch or equipment, pilot light, or other source of ignition around fuel lines.*

A combination gasoline-gaseous fuel carburetor or straight gaseous fuel carburetors are available for use with gaseous fuels. A gaseous fuel system uses a fuel regulator to control the flow of gas from the lines to the carburetor. At the carburetor, the gaseous fuel is mixed with the incoming air.

Gaseous-fuel supply system design, materials, components, fabrication, assembly, installation, testing, inspection, operation and maintenance must comply with the applicable codes. See NFPA Standards No. 30, No. 37, No. 54 and No. 58.

See *Specifications* section for natural gas/LPG fuel inlet size. The recommendations in Onan publication T030, the Application Manual for *Liquid-Cooled Generator Sets*, should be followed in regard to fuel supply system pipe sizes, manual shutoff valves, fuel filters and gas pressure regulators.

Gas Pressure: The fuel regulators in each line provide constant gas pressure at the gas mixer under varying load conditions (approximately 5 inches WC for natural gas and 1.5 inches WC for LPG). There is a pressure test port on the supply side of the gas mixer for measuring fuel inlet pressure.

The maximum permissible fuel supply pressure is 20 inches WC and the minimum is 7 inches WC. This applies to LPG as well as to natural gas. The minimum pressure refers to supply pressure under rated load (maximum gas flow). There is a pressure test port on the supply side of each fuel regulator for measuring fuel supply pressure.

EXHAUST SYSTEM

Pipe exhaust gases to the outside of any enclosure. Locate the exhaust outlets away from any air inlets to avoid gases re-entering the enclosure. Exhaust installations are subject to various detrimental conditions such as extreme heat, infrequent operation and light loads. Regularly inspect the exhaust system both visually and audibly to see that the entire system remains fume tight and safe for operation.

⚠ WARNING *Inhalation of exhaust gases can result in severe personal injury or death. Use extreme care during installation to provide a tight exhaust system. Terminate exhaust pipe away from enclosed areas, windows, doors and vents.*

Use an approved thimble (Figure 4-1) where exhaust pipes pass through wall or partitions. Refer to NFPA 37, Section 6-3. "Stationary Combustion Engines and Gas Turbines" for accepted design practices. Build according to the code requirements in effect at the installation site.

⚠ WARNING *Inhalation of exhaust gases can result in severe personal injury or death. Do not use exhaust heat to warm a room, compartment or storage area.*

Rain caps are available for the discharge end of vertical exhaust pipes. The rain cap clamps onto the end of the pipe and opens due to exhaust discharge force from the generator set. When the generator set is stopped, the rain cap automatically closes, protecting the exhaust system from rain, snow, etc. Check the rain cap periodically for proper operation (cap is not stuck open or closed).

Use a section of flexible exhaust pipe between the engine and remainder of exhaust system. Support exhaust system to eliminate weight applied to engine exhaust outlet elbow/turbocharger connection. The flexible exhaust pipe section is used to eliminate vibration. Do not use to compensate for misalignment of exhaust components.

⚠ CAUTION *Weight applied to the engine manifold can result in turbocharger damage. Support the muffler and exhaust piping so no weight or stress is applied to engine exhaust elbow.*

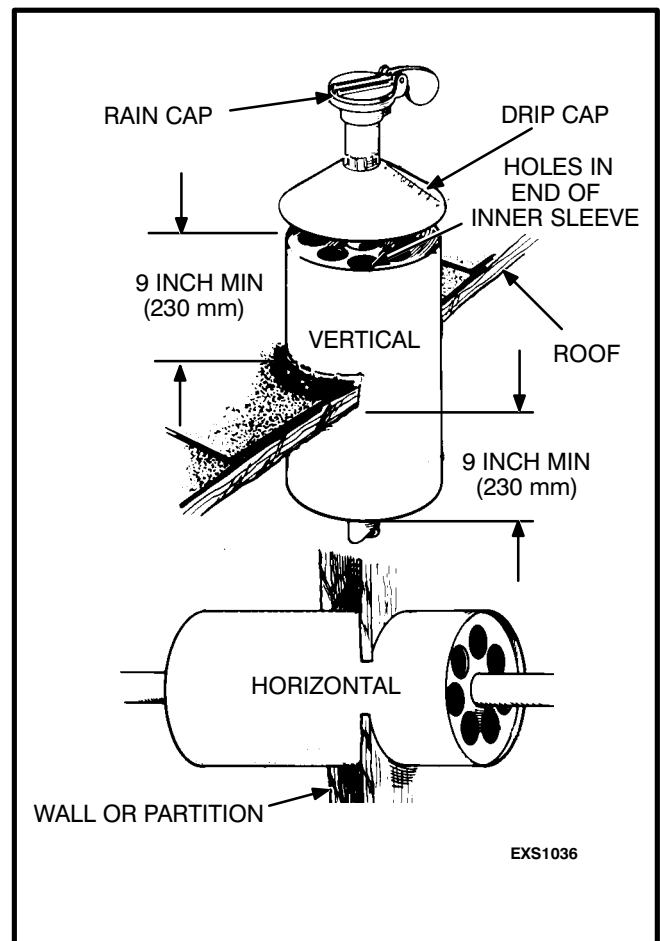

FIGURE 4-1. MOUNTING EXHAUST THIMBLE

Avoid sharp bends by using sweeping, long radius elbows and provide adequate support for muffler and tailpipe. Pitch a horizontal run of exhaust pipe DOWNWARD to allow any moisture condensation to drain away from the engine. If an exhaust pipe must be turned upward, install a condensation trap at the point where the rise begins (Figure 4-2).

Shield or insulate exhaust lines if there is danger of personal contact. Allow at least 12 inches (305 mm) of clearance if the pipes pass close to a combustible wall or partition.

⚠WARNING *Exhaust pipes are very hot and they can cause severe personal injury or death from direct contact or from fire hazard. Shield or insulate exhaust pipes if there is danger of personal contact or when routed through walls or near other combustible materials.*

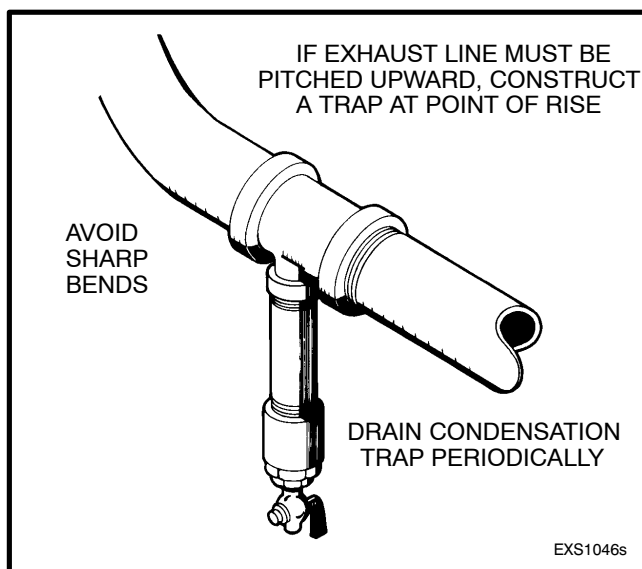

FIGURE 4-2. CONDENSATION TRAP

VENTILATION AND COOLING

Generator sets create considerable heat that must be removed by proper ventilation. Outdoor installations rely on natural air circulation but indoor installations need properly sized and positioned vents for required airflow.

Vents and Ducts

For indoor installations, locate vents so incoming air passes through the immediate area of the installation before exhausting. Install the air outlet higher than the air inlet to allow for convection air movement.

Size the vents and ducts so they are large enough to allow the required flow rate of air. The “free area” of ducts must be as large as the exposed area of the radiator. Refer to the Product Data Sheet for the airflow requirements.

Wind will restrict free airflow if it blows directly into the air outlet vent. Locate the outlet vent so the effects of wind are eliminated. See Figure 4-3.

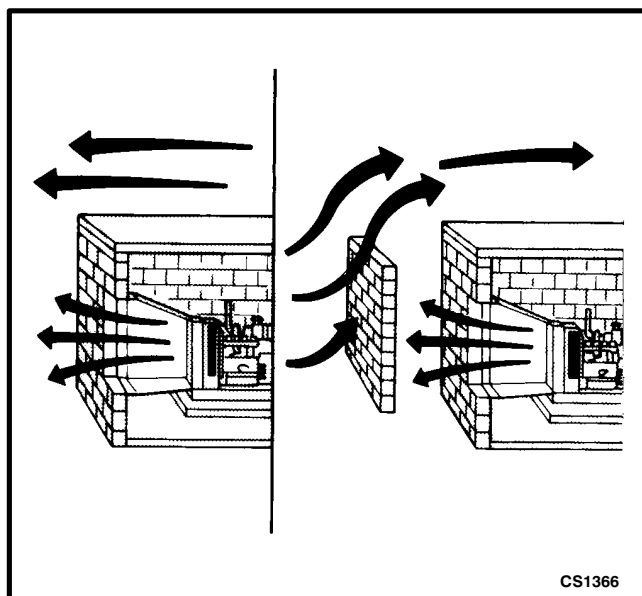

FIGURE 4-3. WIND BARRIER

Dampers

Dampers or louvres protect the generator set and equipment room from the outside environment. Their operation of opening and closing should be controlled by operation of the generator set.

In cooler climates movable or discharge dampers can be used. These dampers allow the air to be recirculated back to the equipment room. This enables the equipment room to be heated by the generator set when operating.

Radiator Set Requirements

Radiator set cooling air is drawn past the rear of the set by a pusher fan that blows air through the radiator (Figure 4-4). Locate the air inlet to the rear of the set. Make the inlet vent opening a minimum of 1-1/2 times larger than the radiator area. **It is important that the inlet and outlet (louvers) do not restrict the cooling air flow beyond the capability of the engine cooling fan. If this capability is exceeded, engine will overheat.**

Locate the cooling air outlet directly in front of the radiator and as close as possible. The outlet opening must be at least as large as the radiator area. Length and shape of the air outlet duct should offer minimum restriction to airflow. Maximum restriction is 0.25 inches WC.

The radiator has an air discharge duct adapter flange. Attach a canvas or sheet metal duct to the flange and the air outlet opening using screws and nuts so duct can be removed for maintenance purposes. The duct prevents recirculation of heated air. Before installing the duct, remove the radiator core guard.

Standard Radiator Cooling uses a set mounted radiator and engine pusher fan to cool engine water jacket. Air travels from the generator end of the set, across the engine and out through the radiator. An integral discharge duct adapter flange surrounds the radiator grille.

Set Mounted Heat Exchanger Cooling uses a liquid-to-liquid heat exchanger that requires a connection to a supply of pressurized cold water and to a drain to discharge the water when it has passed through the heat exchanger. The engine coolant pump pumps coolant through the closed, pressurized loop between the engine and heat exchanger.

The cold water supply line should have a manual shutoff valve, water strainer and 12 VDC water solenoid valve to shut off the water supply when the engine is not running. A thermostatic water flow valve is also recommended. See Application Manual T-030 for more information.

A powered ceiling vent will probably be required for ventilating the generator room.

Remote Radiator Cooling (Optional) substitutes a remote mounted radiator and an electrically driven fan for the set mounted components. Removal of the radiator and the fan from the set reduces noise levels without forcing dependence on a continuous cooling water supply. The remote radiator installation must be completely protected against freezing.

Remote radiator plumbing will vary with installation. Follow recommendations given in Application Manual T-030. See Product Data Sheet for friction head and static head limits.

Before filling cooling system, check all hardware for security. This includes hose clamps, capscrews, fittings and connections. Use flexible coolant lines with heat exchanger, standpipe or remote mounted radiator.

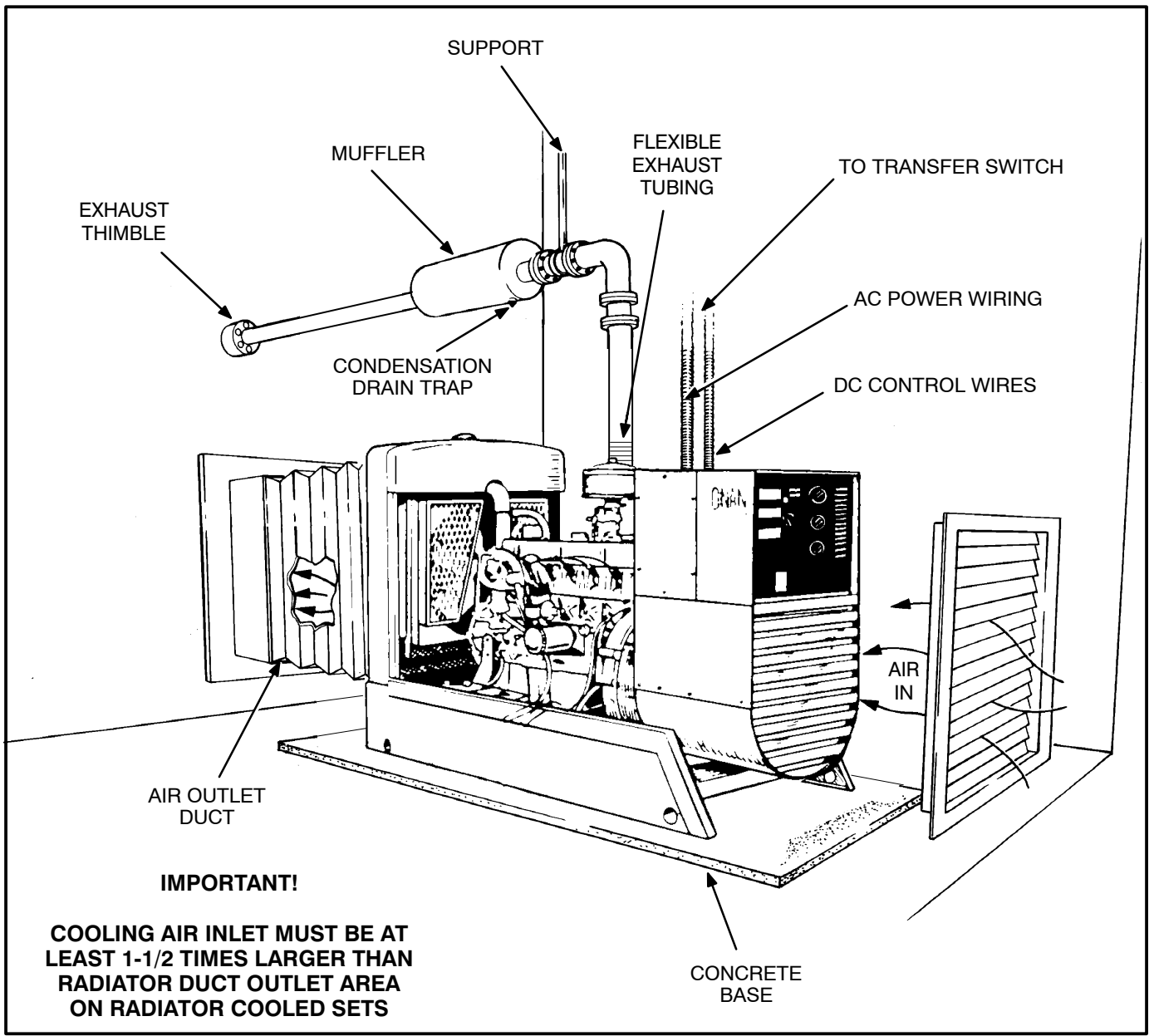

FIGURE 4-4. TYPICAL INSTALLATION

5. Electrical Connections

GENERAL

The generator set electrical system includes connecting the load, installing the control wiring and connecting the batteries. Connect the batteries last to avoid accidental starting of the unit during installation.

⚠ CAUTION *To prevent arcing, always disconnect a battery charger from its AC source before disconnecting the battery cables. Otherwise, disconnecting the cables can result in voltage spikes high enough to damage the DC control circuits of the set.*

⚠ WARNING *Accidental starting of the generator set while working on it can cause severe personal injury or death. Prevent accidental starting by disconnecting the starting battery cables (negative [-] first).*

Arcing can ignite the explosive hydrogen gas given off by batteries, causing severe personal injury. Arcing can occur if the negative (-) battery cable is connected and a tool being used to connect or disconnect the positive (+) battery cable accidentally touches the frame or other grounded metal part of the set. To prevent arcing, always remove the negative (-) cable first, and reconnect it last.

Most local regulations require that wiring connections be made by a licensed electrician and the installation be inspected and approved before operation. All connections, wire sizes, etc. must conform to the requirements of all electrical codes in effect at the installation site.

⚠ WARNING *Improper wiring can cause a fire or electrocution, resulting in severe personal injury or death and/or property and equipment damage.*

TRANSFER SWITCH

If the installation is for standby service, a transfer switch is required for switching the load from the normal power source to the generator set (Figure 5-1). Either a manual or automatic switch can be used. Follow the installation instructions provided with the transfer switch when connecting the load and control wiring.

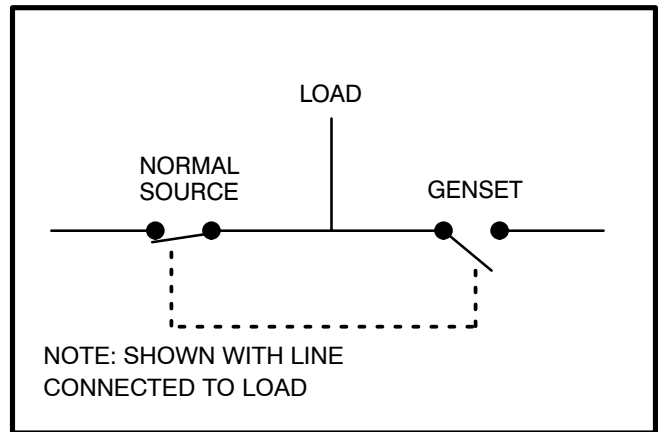

FIGURE 5-1. TYPICAL LOAD TRANSFER SWITCH

AC WIRING

Generator Voltage Connections

The generator output voltage and maximum current rating are specified on the generator set nameplate. Line-to-neutral voltage is always the lower voltage shown and line-to-line voltage is the higher rating.

These generators can be configured for the voltages shown in the Reconnection Diagram. Most of these voltages must be reconnected by the installer to give the voltage required by the installation. Before shipping, the factory tests the generator set output by connecting the generator to produce a particular test voltage. The generator may be connected at the factory to produce a specified voltage per customer order. The installer must always check the stator lead terminal connections and perform any necessary reconnect to obtain the voltage desired. Note that some voltages are available only on certain specific generators.

Refer to Reconnection Diagram when reviewing the voltage connection information and use the electrical schematic supplied with your generator set when actually performing load connections.

⚠ CAUTION *Reconnecting factory connected generator sets to lower voltages can reduce set ratings, and also render line circuit breakers too small. Consult with your distributor before performing reconnection for a different voltage.*

Load Connections

Flexible conduit and stranded conductors must be used for connections to take up movement of the set.

When installing sets with AC meters, the generator output leads must be routed through current transformers for proper meter operation. The transformers are labeled CT21, CT22, and CT23. Refer to

Reconnection Diagram to identify the output leads that must be routed through each current transformer, and also appropriate transformer post selection for meter sensing leads.

Load Balancing

When connecting loads to the generator set, balance the loads so the current flow from each line terminal (L1, L2, and L3) is about the same. This is especially important if both single phase and three phase loads are connected. Any combination of single phase and three phase loading can be used as long as each line current is within 10 percent of median value and no line current exceeds the nameplate rating of the generator. Check the current flow from each line by observing the control panel ammeter.

Grounding

Grounding involves making a conducting connection between the metal parts of the generator set or one of its electrical circuits and the earth. The design and installation of a grounding system is affected by many factors such as the use of multiple transformers, ground fault protection requirements and physical location of the generator. Follow the recommendations of the consulting engineer when installing the grounding system.

⚠ WARNING *Contact with electrical equipment can result in severe personal injury or death. It is extremely important that bonding and equipment grounding be properly done. All metallic parts that could become energized under abnormal conditions must be properly grounded.*

Typical requirements for bonding and grounding are given in the National Electrical Code, Article 250. All connections, wire sizes, etc. must conform to the requirements of the electrical codes in effect at the installation site.

CONTROL WIRING

The generator set control panel box contains connection points for remote control and monitor options. These connection points are located on the Engine Control Monitor board (ECM), the time-delay module and the optional Auxiliary Relay Board (ARB). (Note that if the optional ARB is installed, no remote monitor connections are attached to the ECM. The ARB provides all remote monitor connection points.)

If the distance between the generator set and the remote station is less than 1000 feet (305 m), use 18 gauge stranded copper wire. If the distance is 1000 to 2000 feet (305 to 610 m), use 16 gauge stranded copper wire. Always run control circuit wiring in a sepa-

rate metal conduit from AC power cables to avoid inducing currents that could cause problems within the control.

⚠WARNING **DANGEROUS VOLTAGE** *Touching uninsulated live parts inside the control panel box can result in severe personal injury or death. Control wire installation must be done with care to avoid touching uninsulated live parts.*

For your protection, stand on a dry wooden platform or rubber insulating mat, make sure your clothing and shoes are dry, remove jewelry from your hands and use tools with insulated handles.

ENGINE CONTROL MONITOR BOARD (A11)

The heart of the engine control system is the Engine Control Monitor board (ECM). It is a printed circuit board assembly mounted on the back wall of the control box (Figure 5-2). It starts and stops the engine in response to the control panel switches, engine sensors and remote control signals.

Remote Monitor Connections

The optional Detector 12 Control (12 light panel) provides the capability of attaching a remote monitor panel. Connections are made on the terminal blocks **TB1** and **TB2** located on the ECM board. A detailed connection diagram for the ECM board is provided in Section 9. (If the optional ARB is installed, remote monitor connections attach to the ARB, not the ECM board.)

Function Selection Jumpers

The ECM board has six selection jumpers that can be repositioned to provide the following timed or non-timed warnings or timed or non-timed shutdowns with warnings:

- W1** Jumper Position (jumper **W8** must be in the **B** position):
- A** Non-timed warning under **FLT 2** conditions.
 - B** Non-timed shutdown and warning under **FLT 2** conditions.
 - C** Timed warning under **FLT 2** conditions.

- D** Timed shutdown and warning under **FLT 2** conditions.

- W2** Jumper Position (jumper **W9** must be in the **B** position):

- A** Non-timed warning under **FLT 1** conditions.
- B** Non-timed shutdown and warning under **FLT 1** conditions.
- C** Timed warning under **FLT 1** conditions.
- D** Timed shutdown and warning under **FLT 1** conditions.

- W6** Jumper Position:

- A** Warning under **Pre-High Engine Temperature** conditions.
- B** Shutdown and warning under **Pre-High Engine Temperature** conditions.

- W7** Jumper Position:

- A** Warning under **Pre-Low Oil Pressure** conditions.
- B** Shutdown and warning under **Pre-Low Oil Pressure** conditions.

- W8** Jumper Position:

- A** Warning while running or during standby under **FLT 2** conditions.
- B** Allows selection of functions with **W1** jumper.

- W9** Jumper Position:

- A** Warning while running or during standby under **FLT 1** conditions.
- B** Allows selection of functions with **W2** jumper.

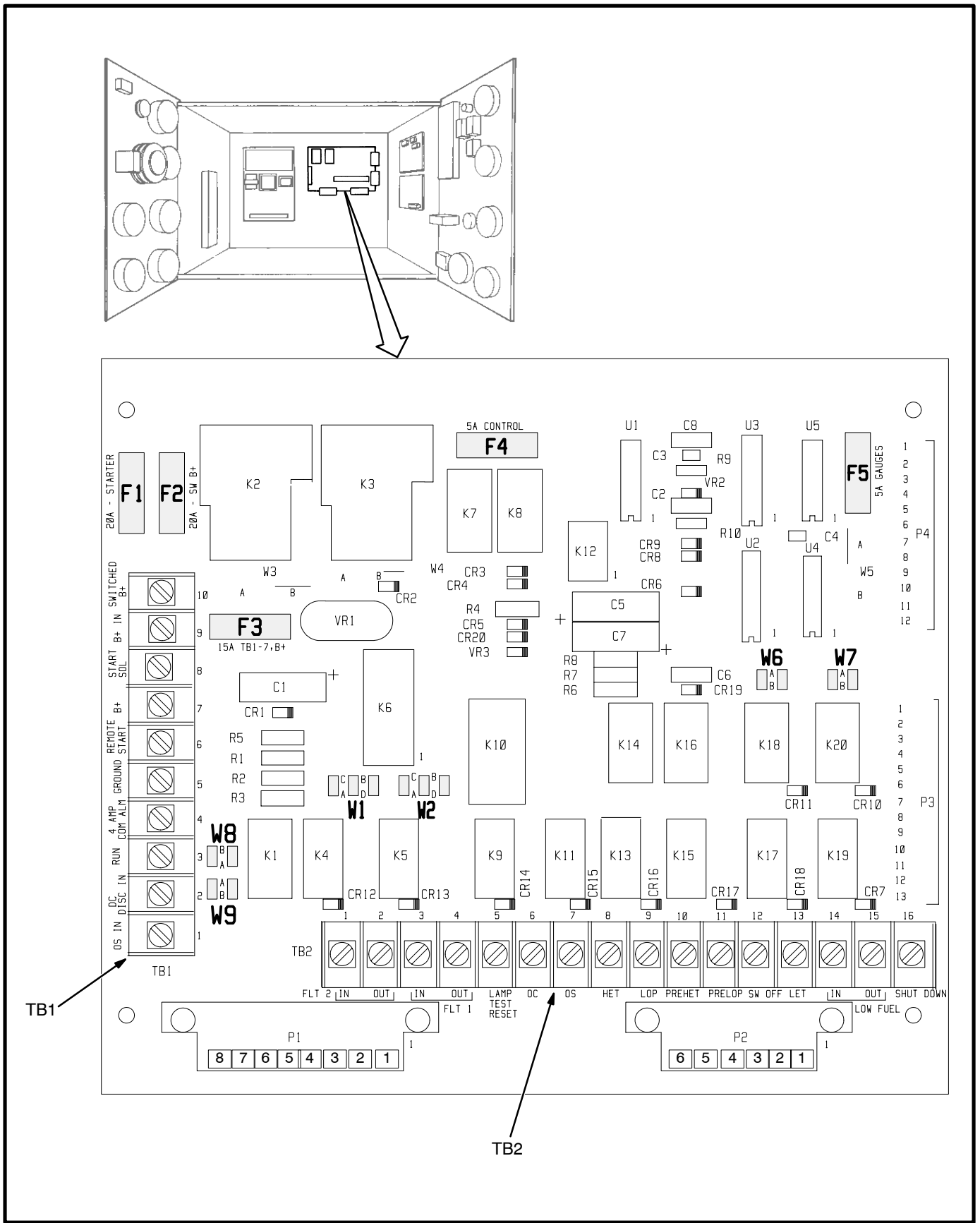

FIGURE 5-2. ENGINE CONTROL MONITOR BOARD (ECM)

AUXILIARY RELAY BOARD (OPTIONAL)

The following describes the design/functional criteria for the Auxiliary Relay Board (ARB) with a Detector-7 or -12 Generator set control. When provided, the board is mounted on the right wall of the control box. See Figure 5-3. There are two versions of the ARB; with and without the set of 12 Fault relays. A detailed connection diagram for the ARB is provided in Section 9.

Terminal Blocks:

- **TB1** – ARB TB1 and ECM board TB1 are identically numbered and provide the same remote control connection points. Note that additional terminals are provided for terminals 5, 7, and 10 of ARB TB1.
- **TB2 through TB5** – Connection points for relays K1 through K3. TB2 provides the N/O and N/C connections (three form 'C' contacts for each relay). TB3 through TB5 provide the common connection points (TB3 for K1, TB4 for K2 and TB5 for K3).
- **TB6 and TB7** – Connection points for fault relays K4 through K15. Three terminals are provided for each relay, which are labeled COM, N/C, N/O.

Plug-In Relays (K1, K2, K3): The ARB can be equipped with one to three 3-pole, double-throw relays. These relays (K1, K2, K3) are field changeable plug-in relays for easy field addition and replacement.

Each relay can be operated as a RUN, COMMON ALARM, or ISOLATED COIL with the changing of a jumper.

The relay contact ratings are:

- 10 amps at 28 VDC or 120 VAC, 80% PF
- 6 amps at 240 VAC, 80% PF
- 3 amps at 480 VAC, 80% PF

Jumper Positions for Plug-In Relays: Jumpers W1, W2 and W3 perform the same functions for their respective relays, W1 for relay K1, W2 for relay K2, and W3 for relay K3. They can be located in any of 3 positions (A, B, C) independently of each other.

- **Jumper Position A (Run)** – The relay operates as a Run relay, energizing when SW B+ is applied from the engine monitor.
- **Jumper Position B (Common Alarm)** – The relay operates as a Common Alarm relay. The relay energizes any time there is an engine fault shutdown. This fault signal is provided from the engine.
- **Jumper Position C (Isolated)** – The relay operates as an Isolated relay. The relay coil is energized by a customer applied B+ signal through the terminal block; TB3-1 for relay K1, TB4-1 for relay K2, and TB5-1 for relay K3.

Jumpers W11, W12, and W13 perform the same functions for their respective relays; W11 for relay K1, W12 for relay K2, and W13 for relay K3. They can be located in two different positions (A, B) independently of one another.

- **Jumper Position A** – The relay operates isolated from the board. The customer provides the circuit completion through terminal block; TB3 for relay K1, TB4-5 for relay K2, and TB5-5 for relay K3. The customer can operate the relay with switched ground logic or use this relay in the middle of more complex logic circuits if needed.
- **Jumper Position B** – The relays operate with the coils connected to ground through the board connections. The coil will require a B+ signal to energize with the jumper in this position.

Fault Relays (K4 through K15): These optional relay modules are used to operate a remote alarm annunciator that has an independent power source. This allows the use of either AC or DC for alarm drives. The relays are energized through the latching relays on the engine monitor and provided N/O and N/C contacts for each external alarm connection.

The 12 relays with form 'C' contacts are rated:

- 10 Amp, 120 VAC
- 10 Amp, 30 VDC

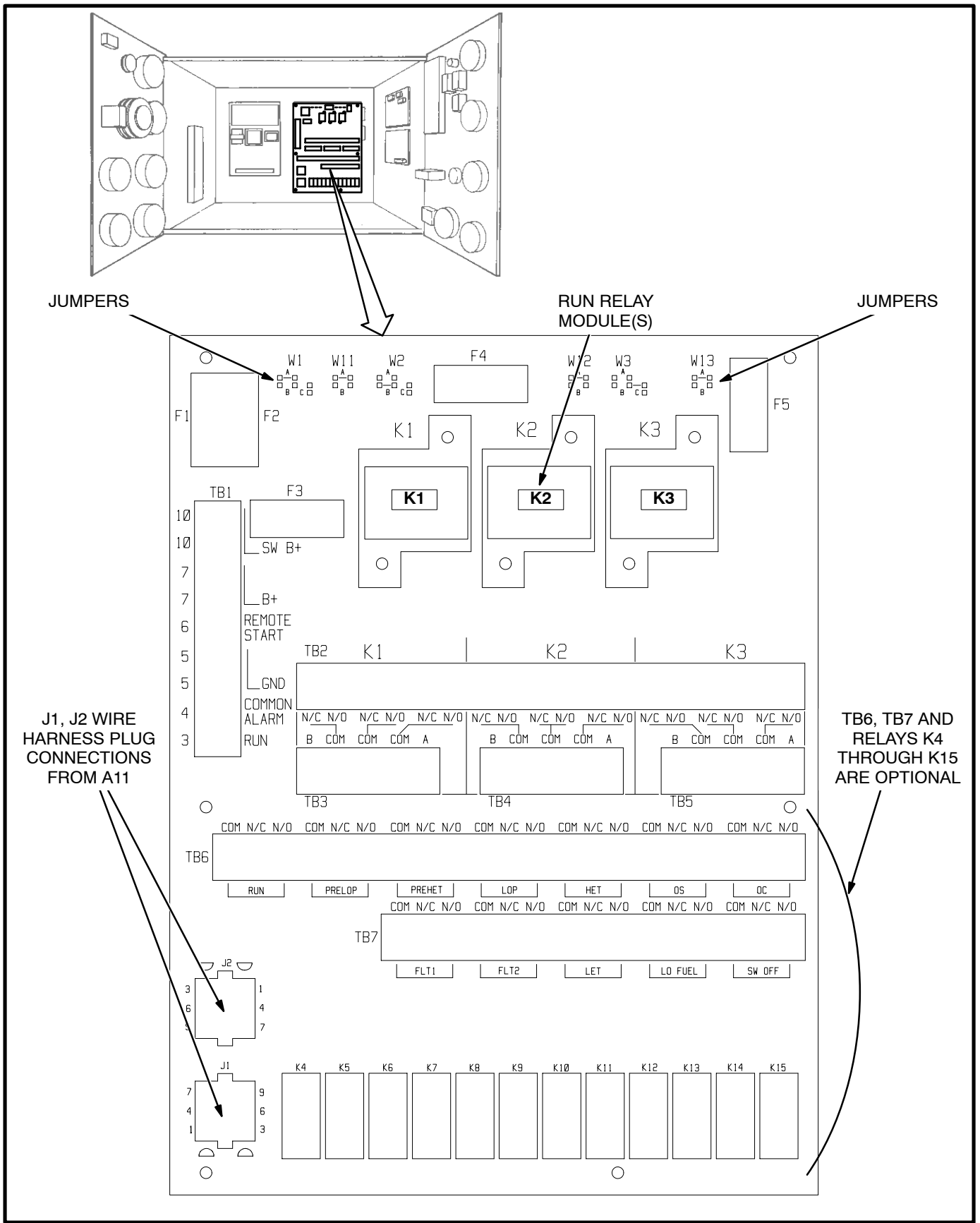

FIGURE 5-3. AUXILIARY RELAY BOARD (ARB)

TIME-DELAY MODULE (A15)

The start delay is adjustable from 5 to 15 seconds and the stop delay from 30 seconds to 30 minutes. Turn the delay adjusting potentiometers clockwise to increase delay and counterclockwise to decrease delay.

Remote Control Connections

Remote control connections are made at the terminal block (TB1) that is located on the time-delay module (Figure 5-4). Connect one or more remote switches across the remote terminal (TB1-5) of the time-delay module and the B+ terminal of the ECM board.

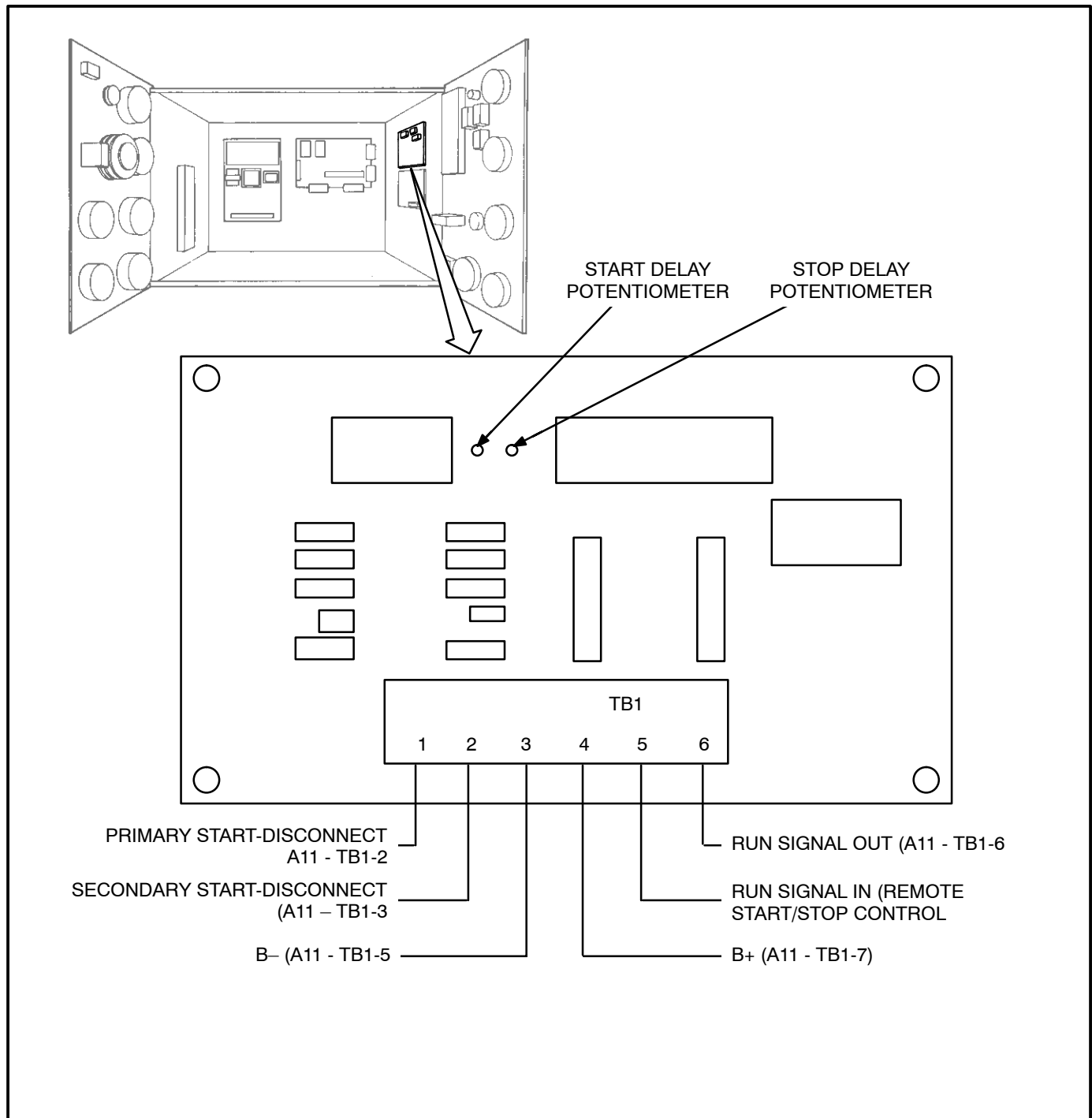

FIGURE 5-4. TIME-DELAY MODULE

6. Prestart Preparations

GENERAL

Before attempting the initial start of the generator set, be sure it is serviced and ready for operation. Refer to the Maintenance section of the Operator's Manual for the recommended procedures for adding oil, coolant or fuel.

Generator sets are shipped with oil and coolant added. Be sure to check these systems to make sure they are at proper operating levels before starting.

LUBRICATION

Before starting, check the engine dipstick and if required, fill the crankcase with the recommended oil.

COOLANT

Before starting, check the coolant recovery tank on the radiator and fill (between *LOW* and *FULL* mark) with the recommended coolant.

FUEL

Open all manual shutoff valves.

VENTILATION

Verify all air vents and ducts are open and free from any obstructions. Verify dampers, if used, operate properly.

EXHAUST SYSTEM

Check the exhaust system for proper installation. Verify there is at least 12 inches (305 mm) clearance between exhaust pipes and combustible materials.

ELECTRICAL SYSTEM

Verify all electrical connections are secure and all wiring is complete and inspected. Replace and secure any access panels that may have been removed during installation.

Battery Connections

Use one 12 volt battery for a normal installation. Connect positive battery cable before connecting negative (GND) battery cable to prevent arcing.

Service the battery as necessary. If an automatic transfer switch is installed without a built-in charge circuit, connect a separate trickle charger.

MECHANICAL CHECKS

Check the generator set for loose or damaged components and repair or replace as required.

7. Initial Start and Checks

Before putting the generator set under load conditions, verify the set will perform correctly by checking the following areas.

STARTING

Move the Run/Stop/Remote switch on the engine control panel to the Run position. The starter should crank the engine and the engine should start within a few seconds. If after a few seconds of cranking the engine fails to start or starts, runs and then stops, refer to Troubleshooting charts in the Operator's Manual.

ENGINE GAUGES

Check the following while the generator set is operating:

Oil Pressure Gauge

The oil pressure should be in the range of 35 to 60 psi (240 to 415 kPa) when the engine is at operating temperature.

Water Temperature Gauge

The water temperature should be in the range of 180° to 195°F (83° to 91°C) depending on the load and ambient temperature.

DC Ammeter/DC Voltmeter

The maximum charge rate for the set mounted battery charging alternator is 65 amperes. Charge rate should taper to zero following start-up as battery becomes charged.

AC METERS (IF EQUIPPED)

Note the AC instruments on the control panel. The frequency meter and voltmeter should indicate

rated nameplate frequency and voltage. Turn the control panel Voltage Adjust control (if equipped) for nameplate voltage. Use the Phase Selector Switch to read each of the line-to-line voltages.

Frequency Meter

The generator frequency should be stable and the reading should be the same as the nameplate rating (50 or 60 hertz).

AC Voltmeter

Turn the phase selector switch to each line-to-line phase selection shown on the volts scale (L1-L2 on single phase sets; L1-L2, L2-L3, and L3-L1 on three phase sets). Read the AC voltmeter using the upper or lower scale as indicated by the scale indicator light. At no load, the line-to-line voltage should be the same as the set nameplate rating.

AC Ammeter

Turn the phase selector switch to each phase selection shown on the amperes scale (L1 and L2 on single phase sets; L1, L2, and L3 on three phase sets). Read the ammeter using the upper or lower scale as indicated by the scale indicator light. At no load, the current readings should be zero. With a load applied, each line current should be approximately the same and no line current should exceed the set nameplate reading.

ENGINE MONITOR INDICATOR LAMPS

Hold the Reset/Lamp Test switch in the Test position. All indicator lamps should light. Verify all the lamps are on and then release the switch. Contact your authorized service center if any lamps require replacement.

EXHAUST SYSTEM

With the generator set operating, inspect the entire exhaust system including the exhaust manifold, muffler and exhaust pipe. Visually and audibly check for leaks at all connections, welds, gaskets and joints. Make sure exhaust pipes are not heating surrounding areas excessively. If any leaks are detected, have them corrected immediately.

⚠️WARNING *Inhalation of exhaust gases can result in severe injury or death. Inspect exhaust system visually and audibly for leaks daily. Shut down generator set and repair any leaks immediately.*

FUEL SYSTEM

With the generator set operating, inspect the fuel supply lines, filters and fittings for leaks. Check any flexible sections for cuts, cracks and abrasions and make sure they are not rubbing against anything that could cause breakage.

⚠️WARNING *Leaking fuel will create a fire hazard that can result in severe personal injury or death if ignited by a spark. If any leaks are detected, shut down generator set and have them corrected immediately.*

DC ELECTRICAL SYSTEM

With the generator set off, check the terminals on the battery for clean and tight connections. Loose or corroded connections create resistance that can hinder starting. Clean and reconnect the battery cables if loose. Always connect the negative battery cable last.

⚠️WARNING *Ignition of explosive gases can cause severe personal injury. Do not smoke while servicing the batteries.*

COOLING SYSTEM

Before starting the engine for the first time, remove the radiator pressure cap and monitor the coolant level. As trapped air is expelled from the system, the coolant level will drop and additional coolant must be added. Replace the pressure cap when the coolant level is stable.

MECHANICAL ADJUSTMENTS

With the generator stopped, check for loose belts and fittings, leaking gaskets and hoses, or any signs of mechanical damage. If any problems are found, have them corrected immediately.

With the set running, listen for any unusual noises that can indicate mechanical problems. Check the oil pressure frequently. Refer to Operator's or Service Manual for required adjustments.

8. Installation Checklist

GENERAL

- Generator set wattage capacity is sufficient to handle maximum anticipated load.
- At least 3 feet of clearance is provided around entire genset for servicing and ventilation.
- Generator set is located in an area not subject to flooding.
- All operating personnel have read and are familiar with Operator's Manual.
- All operators have been thoroughly briefed on correct operation and exercise procedures.
- All operators have been thoroughly briefed on preventive maintenance procedures.
- All operators have read and understand all Safety Precautions in Operator's Manual.

GENSET SUPPORT

- Floor, roof or earth on which the genset rests is strong enough and will not allow shifting or movement. Observe local codes on soil bearing capacity due to freezing and thawing.
- Generator set is properly supported and retained to approved base which is separate and independent of the surface on which it sits. Vibration isolators are installed between base and set.
- Supporting base is large enough - extends 12-inches all around set.

COOLING AIR FLOW

- Generator set air inlet is faced into direction of strongest, prevailing winds.
- Air inlet openings are unrestricted and at least 1-1/2 times larger than air outlet area.
- Cooling air outlet is on downwind side of building (if not, wind barrier is constructed).
- Proper ducting material (sheet metal, canvas) is used between radiator and air outlet.

FUEL SYSTEM

- Fuel tanks meet or exceed all local, state or national codes.
- Fuel lines are properly installed, supported and protected against damage.
- Flexible fuel line is installed between main fuel supply line and generator set to protect against vibration, expansion and contraction.
- Fuel line shutoff valves are installed to prevent fuel flow in case of leaks.
- External fuel pumps are connected and operated to be turned On when generator set is started and turned Off when genset is shut down.
- No fuel leaks are found in supply line or engine fuel system.

EXHAUST SYSTEM

- Operators are thoroughly briefed on the dangers of carbon monoxide gas, preventing the buildup of this gas in inhabited areas.
- Areas around set are well ventilated. No possibility of exhaust fumes entering building doors, windows, or intake fans.
- Exhaust gases are piped safely outside and away from building.
- The correct length of approved rigid pipe is connected to the genset flexible pipe using approved securing methods with no weight resting on engine exhaust components. There are no bends in flex section.
- Condensation drain is provided in lowest section of exhaust piping.
- Exhaust piping is insulated to guard against burns to personnel.
- Exhaust piping passing through walls or ceilings have approved fire-proof materials and are in compliance with all codes.
- Exhaust piping is large enough in diameter to prevent back pressure on engine.
- Rain cap is installed if required.

AC AND DC WIRING

- Wire sizes, insulation, conduits and connection methods all meet applicable codes.
- AC and DC wires are separated in their own conduit to prevent electrical induction.
- All load, line and generator connections are proper and correct.

GENSET PRESTART

- Generator set engine is properly serviced with oil and coolant.
- Batteries are properly installed, serviced and charged.
- Battery charger and engine coolant heater are connected and operational.
- All genset covers and safety shields are installed properly.
- All fuel and coolant shutoff valves are operational.
- Fuel system is primed.

9. Wiring Diagrams

GENERAL

This section consists of the schematic and connection wiring diagrams referenced in the text. The following drawings are included.

- Page 9-3 – Customer Connections at the Engine Control Monitor Board
- Page 9-4 – Customer Connections at the Auxiliary Relay Board
- Page 9-5 – Accessory Interconnect Diagram

TB1-10 (SWITCHED B+ OUTPUT) OUTPUT TO RELAY K12, FUSED AT 20 AMPS, ENERGIZED WHEN THE START SIGNAL IS APPLIED AND DE-ENERGIZED AT SHUTDOWN (NORMAL AND FAULT)

TB1-9 (B+ INPUT) BATTERY POSITIVE (+) CONNECTION

TB1-8 (START SOLENOID) OUTPUT TO RELAY K11, FUSED AT 20 AMPS

TB1-7 (B+ OUTPUT) OUTPUT TO TIME DELAY START/STOP MODULE A15, FUSED AT 15 AMPS, AVAILABLE WHEN THE STARTING BATTERIES ARE CONNECTED

TB1-6 (REMOTE START) CONNECTED TO TIME DELAY START/STOP MODULE A15. CONNECT REMOTE START CONTACT OF THE AUTOMATIC TRANSFER SWITCH TO TERMINAL TB1-5 OF MODULE A15.

TB1-5 (GROUND)

TB1-4 (COMMON ALARM B+ OUTPUT) 4 AMP RATED DEVICE MAXIMUM

TB1-3 (RUN) CONNECTED TO TIME DELAY START/STOP MODULE A15

TB1-2 (DC DISCONNECT) CONNECTED TO TIME DELAY START/STOP MODULE A15

THIS IS A REPRESENTATIVE (GENERIC) SCHEMATIC/WIRING DIAGRAM. FOR TROUBLESHOOTING, REFER TO THE WIRING DIAGRAM PACKAGE THAT WAS INCLUDED WITH YOUR GENSET.

TB2-1 (FAULT 2) GROUND INPUT FROM SENDER

TB2-2 (FAULT 2) GROUND OUTPUT TO LIGHT/RELAY*

TB2-3 (FAULT 1) GROUND INPUT FROM SENDER

TB2-4 (FAULT 1) GROUND OUTPUT TO LIGHT/RELAY*

TB2-5 (REMOTE RESET) MOMENTARY CONTACT TO GROUND

TB2-6 (OVERCRANK FAULT) GROUND OUTPUT TO LIGHT/RELAY*

TB2-7 (OVERSPEED FAULT) GROUND OUTPUT TO LIGHT/RELAY*

TB2-8 (HIGH ENGINE TEMPERATURE FAULT) GROUND OUTPUT TO LIGHT/RELAY*

TB2-9 (LOW OIL PRESSURE FAULT) GROUND OUTPUT TO LIGHT/RELAY*

TB2-10 (PRE-HIGH ENGINE TEMPERATURE WARNING) GROUND OUTPUT TO LIGHT/RELAY*

TB2-11 (PRE-LOW OIL PRESSURE WARNING) GROUND OUTPUT TO LIGHT/RELAY*

TB2-12 (SWITCH OFF WARNING) GROUND OUTPUT TO LIGHT/RELAY*

TB2-13 (LOW ENGINE TEMPERATURE WARNING) GROUND OUTPUT TO LIGHT/RELAY*

TB2-14 (LOW FUEL WARNING) GROUND INPUT FROM SENDER

TB2-15 (LOW FUEL WARNING) GROUND OUTPUT TO LIGHT/RELAY*

TB2-16 (EMERGENCY SHUT DOWN) MOMENTARY CONTACT TO GROUND

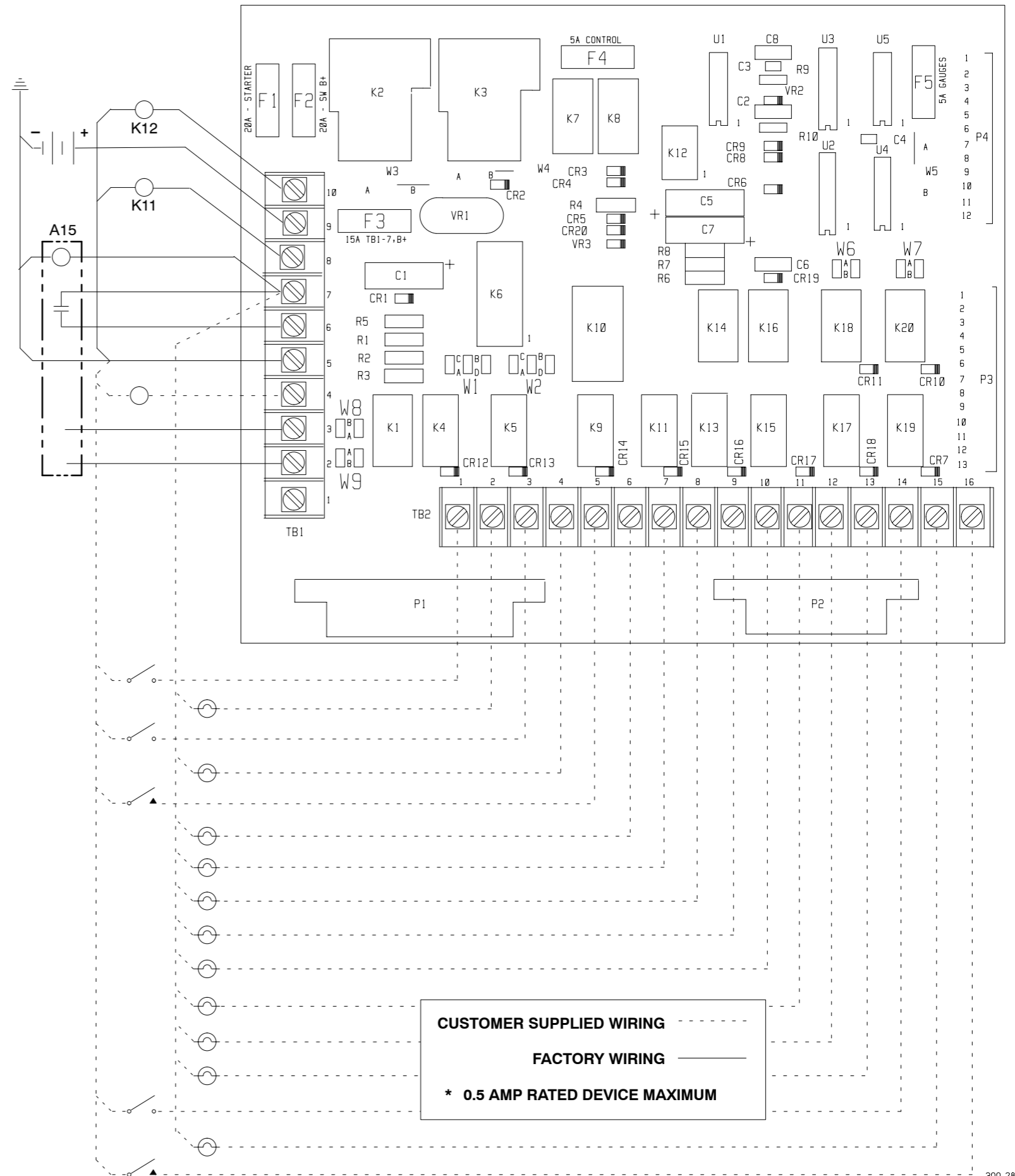

CUSTOMER CONNECTIONS AT THE ENGINE CONTROL MONITOR BOARD

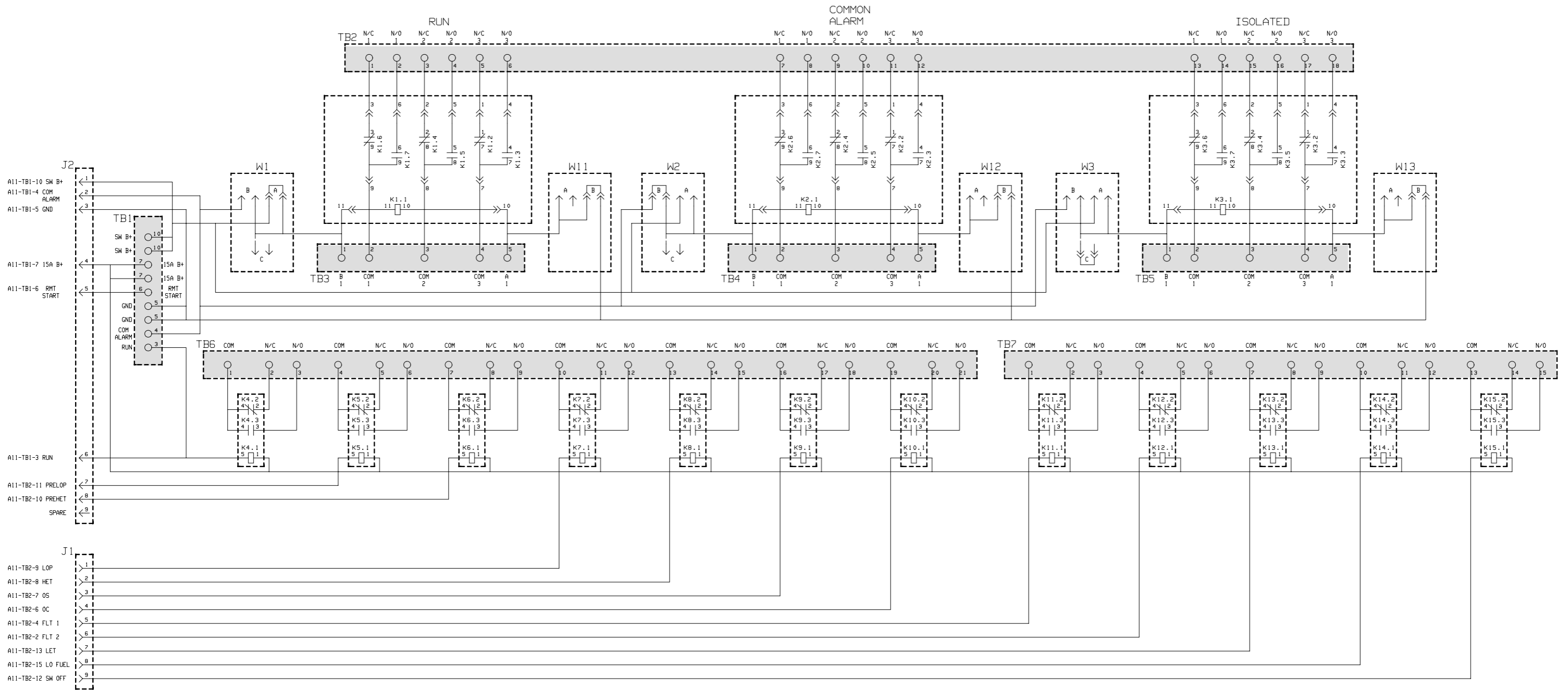

THE TERMINALS IN THE SHADED BOXES ARE FOR CUSTOMER CONNECTIONS

THIS IS A REPRESENTATIVE (GENERIC) SCHEMATIC/WIRING DIAGRAM. FOR TROUBLESHOOTING, REFER TO THE WIRING DIAGRAM PACKAGE THAT WAS INCLUDED WITH YOUR GENSET.

RECONNECT DIAGRAMS



OT & BT 2 WIRE START
UTILITY TO GENSET

THIS IS A REPRESENTATIVE (GENERIC) SCHEMATIC/WIRING DIAGRAM. FOR TROUBLESHOOTING, REFER TO THE WIRING DIAGRAM PACKAGE THAT WAS INCLUDED WITH YOUR GENSET.

ONAN ENGINE/CUMMINS GENERATOR SET WITH DETECTOR 7
OR DETECTOR 12 CONTROL

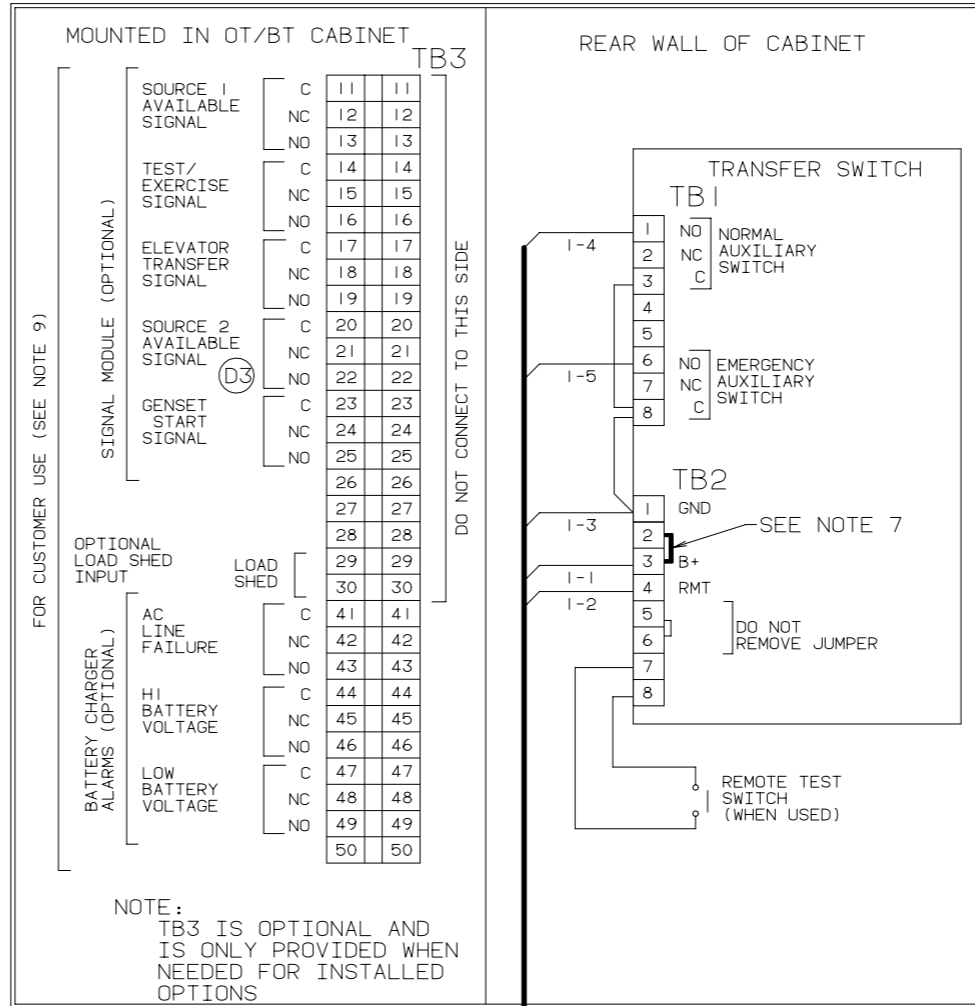
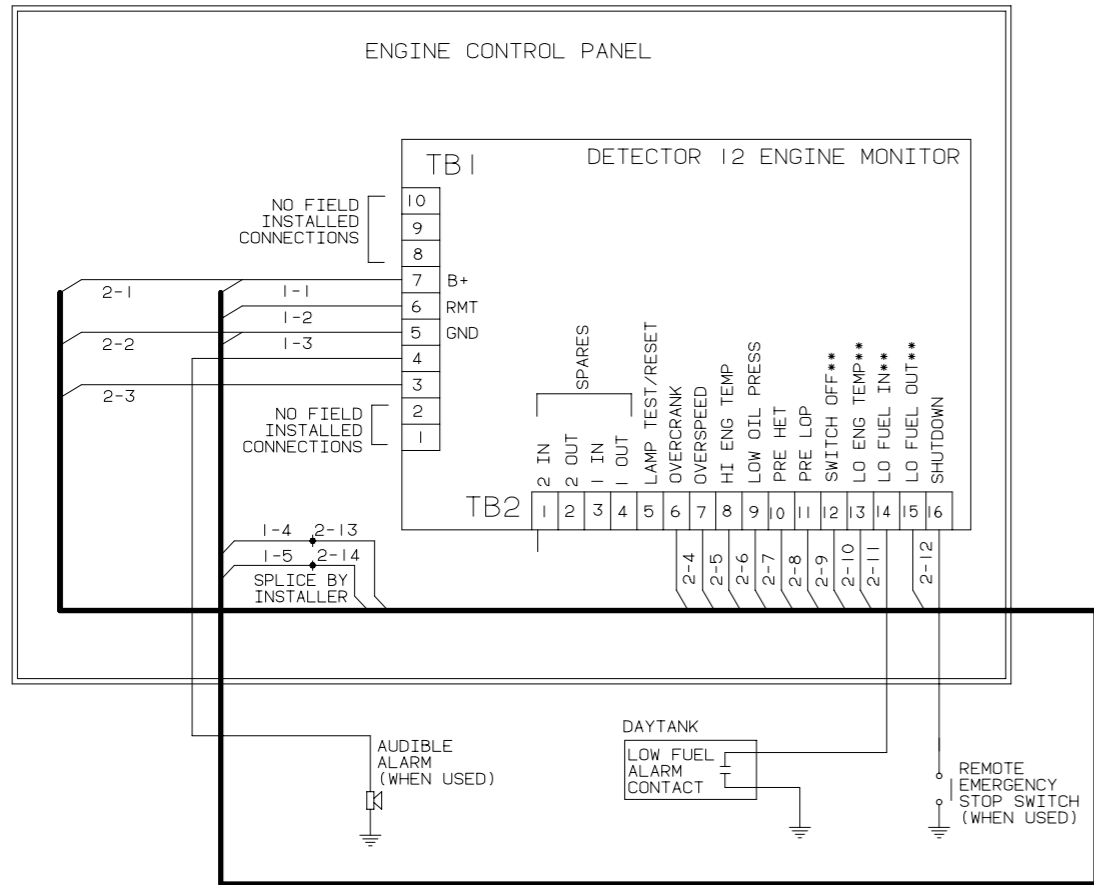

NOTE:
TB3 IS OPTIONAL AND IS ONLY CHARGER WHEN NEEDED FOR INSTALLED OPTIONS

- NOTES:
1. WIRE SIZES MUST BE AS FOLLOWS:
RUN #1-GENSET TO TRANSFER SWITCH-LEAD SIZE MUST BE INCREASED IF A BATTERY CHARGER IS INSTALLED IN THE SWITCH.
WITH NO BATT CHARGER-LEADS 1-1, -2, -3, -4, -5 USE COL. A
WITH 2 AMP CHARGER-LEADS 1-1 & 1-3, USE COL. B
WITH 10 AMP CHARGER-LEADS 1-1 & 1-3, USE COL. C
 2. RUN #2-GENSET TO ANNUNCIATOR-ALL LEADS, USE COL. A
 3. FOR MULTIPLE TRANSFER SWITCHES, DUPLICATE RUN #1 FOR EACH SWITCH. DAISY CHAIN CONNECTION IS ACCEPTABLE PROVIDED WIRE SIZE & DISTANCE TO THE LAST SWITCH MEET THE SPECS IN NOTE 1.
 - 4.
 - 5.
 6. FUNCTIONS INDICATED BY ** ARE NOT INCLUDED IN THE DETECTOR 7 CONTROL. JUMPER TB2-14 TO TB2-15 FOR LOW FUEL ALARM.
 7. INSTALL JUMPER BETWEEN TB2-2 & TB2-3.
 8. 300-4510-XX ANNUNCIATOR MAY BE USED ALSO. WIRE TBI AS SHOWN.
 9. CONTACTS RATED: 4 AMPS AT 30 VDC OR 120V MAX.

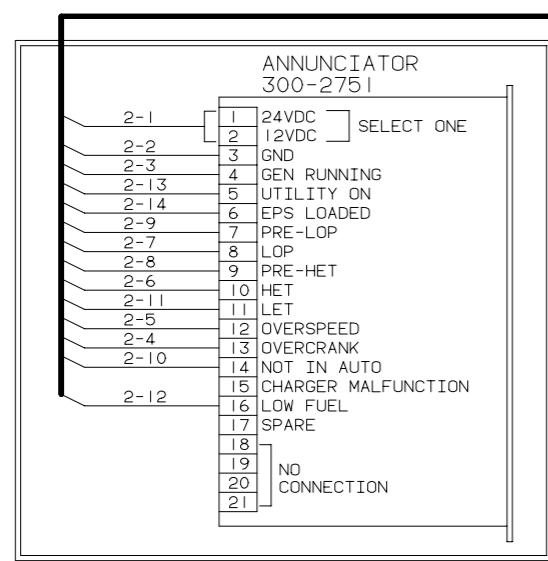

WIRE SIZE (AWG)	DISTANCE IN FEET, ONE WAY (MULTIPLY BY 0.3 FOR METERS)		
	A	B	C
16	1000	125	25
14	1600	200	40
12	2400	300	60
10	4000	500	100

ACCESSORY INTERCONNECT DIAGRAM

NO. 630-1345 sh3
REV. E
MODIFIED 6/29/94



Cummins Power Generation
1400 73rd Avenue N.E.
Minneapolis, MN 55432
1-800-888-6626
763-574-5000 International Use
Fax: 763-528-7229

Cummins is a registered trademark of Cummins Inc.



Redistribution or publication of this document by any means, is strictly prohibited.