

Operator Manual

Transfer Switch

1200-3000 Amps, Utility-to-Generator Set

CN (Spec G-J)

CT (Spec G-J)

ON (Spec G-J)

OT (Spec G-J)

OTA (Spec G-J)

OTB (Spec G-J)

OTC (Spec G-J)

OTD (Spec G-J)

Supplement 962-1027

Date: 4-2013

Insert with-

Title: OT III Transfer Switch Manuals

Numbers: 962-0113, 962-0116, 962-0118
962-0125, 962-0600, 962-0602
962-0604, 962-0611, 962-0512
962-0513

Title: BT Transfer Switch Manuals

Numbers: 962-0121, 962-0607, 962-0514

PURPOSE

A new exerciser/change-over clock is available that requires new programming instructions. If the exerciser/change-over clock in the transfer switch matches the one shown in Figure 1 of this supplement, follow the programming instructions provided in this supplement.

This clock is referred to as an exerciser clock in manuals that cover utility-to-genset applications and it is called a change-over clock in genset-to-genset applications. The clock is the same for both applications. Refer to the manuals provided with the transfer switch for important safety precautions and for general information on *exercising* or *changeover*.

Keep this copy with the transfer switch manuals for future reference.



NEW EXERCISER/CHANGE-OVER CLOCK

The clock is used as an exerciser clock in **utility-to-genset applications**. The clock is set to start and run the generator set at programmable intervals and for selected durations.

In **genset-to-genset applications**, the clock is used as a change-over clock to initiate generator set changeover at programmable intervals. When programming for a changeover, the program is set only long enough to allow the genset to start. (As an example, if the clock is programmed to come ON once each week for five minutes, a changeover will occur between the generator sets at that time.)

The clock is a 7-day, 24-hour clock that can store and execute up to four start/stop programs per day (one minute minimum duration). The clock also has a test feature that can be used to initiate a genset start and run cycle.

Programming the exerciser/change-over clock requires setting the time of day and entering the start and stop times as described in the following sections.

The clock has backup power for a minimum of six hours. After loss of backup power, the day and time will have to be reset. Exerciser/change-over programs will not be lost during a power outage (programs are stored in EEPROM).

To Reset The Clock:

Resetting the clock erases all existing day, time and program settings.

Depress and hold the (-) (+) (Menu) & (OK) buttons simultaneously. When all aspects of the LCD display appear, release the depressed buttons. The word RESET will appear on the screen and then the display will return to its default date of (1/1/2004) and time of (0:00).

To Set The Day And Time:

1. With the clock powered, press (-) (+) (Menu) & (OK) buttons to reset the time. The time display area will show (0:00).

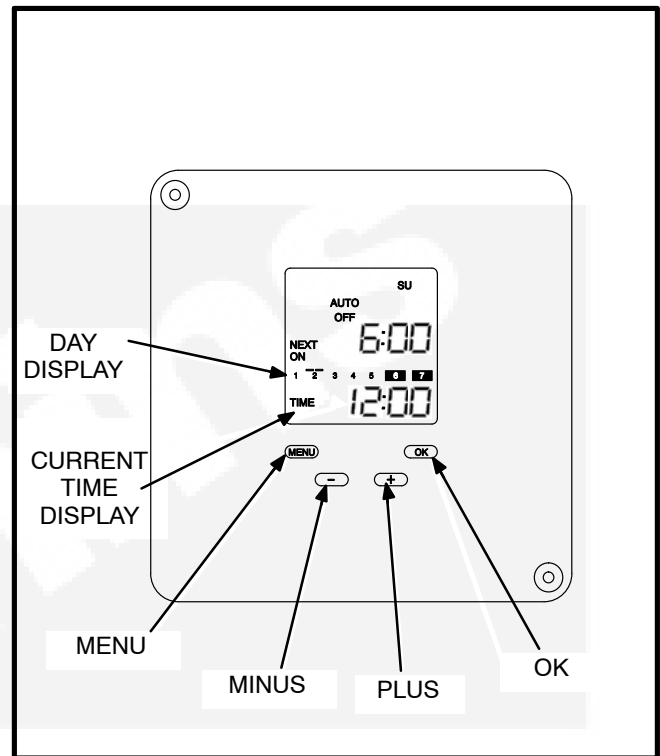

FIGURE 1. EXERCISER/CHANGEOVER CLOCK

2. Press the (MENU) button once, the LDC display will show SET, PROG, and MODE for options. If the word SET is flashing, press the (OK) button.
3. The LDC display will show SET with TIME/DATE or SU WI for options. If TIME/DATE is flashing, press the (OK) button.
4. Press the (-) and (+) buttons to set the hour of day. The clock uses 24-hour (military) time. Once the correct hour is displayed, press the (OK) button.
5. Press the (-) and (+) buttons to set the minutes of the hour. Holding down the (-) and (+) buttons will increment or decrement the display by 1 minute increments. Once the correct minutes are displayed, press the (OK) button.
6. Press the (-) and (+) buttons to set the correct day of the month. Once the correct day of month is displayed, press the (OK) button.
7. Press the (-) and (+) buttons to set the correct month of the year. Once the correct month of year is displayed, press the (OK) button.
8. Press the (-) and (+) buttons to set the correct year. Once the correct year is displayed, press the (OK) button.

To Set For Daylight Savings Time:

1. Press the (MENU) button once, the LCD display will show SET, PROG, and MODE for options. If the word SET is flashing, press the (OK) button.
2. The LCD display will show SET with TIME/DATE or SU WI for options. If TIME/DATE is flashing, press the (+) button once to make the SU WI flash.
3. Once the SU WI is flashing, press the (OK) button.
4. The LCD display will show EU, press the (-) or (+) buttons to choose from EU (European daylight savings time), US (United States daylight savings time), no SU:WI (no daylight savings time) or SPECIAL (customized daylight savings time setup).
 - A. For European daylight savings time:
 - 1) Press the (-) or (+) buttons until EU is displayed.
 - 2) Once EU is displayed, press the (OK) button.
 - B. For US daylight savings time:
 - 1) Press the (-) or (+) buttons until US is displayed.
 - 2) Once US is displayed, press the (OK) button
 - C. For no daylight savings time:
 - 1) Press the (-) or (+) buttons until no SU:WI is displayed.
 - 2) Once no SU:WI is displayed, press the (OK) button.
 - D. For customized daylight savings time:
 - 1) Press the (-) or (+) buttons until SPECIAL is displayed.
 - 2) Once SPECIAL is displayed, press the (OK) button.
 - 3) Press the (-) and (+) buttons to set the day of the month the summer daylight savings observance begins, then press the (OK) button.
 - 4) Press the (-) and (+) buttons to set the month the summer daylight savings observance begins, then press the (OK) button.
 - 5) Press the (-) and (+) buttons to set the year the summer daylight savings observance begins, then press the (OK) button.

- 6) Press the (-) and (+) buttons to set the day of the month the winter daylight savings observance begins, then press the (OK) button.
- 7) Press the (-) and (+) buttons to set the month the winter daylight savings observance begins, then press the (OK) button.
- 8) Press the (-) and (+) buttons to set the year the winter daylight savings observance begins, then press the (OK) button.

To Set The Exerciser Start and Stop Time:

1. Press the (MENU) button once, the LCD display will show SET, PROG, and MODE for options. If the word PROG is flashing, press the (OK) button.
2. The LCD display will show PRO with NEW MODIFY and TEST for options. If PROG is flashing, press the (+) button once to make NEW flash.
3. Once the NEW is flashing, press the (OK) button.
4. The LCD will then display the amount of currently available programs that can be created.
 - A. The LCD will show FREE XX PR (which means you have space for XX programs to be created).
5. Once the LCD displays FREE XX PR, press the (OK) button.
6. Press the (-) or (+) buttons to choose between the program options.
 - A. Daily Exercising
 - 1) The LCD will display DAY (with 1-7) flashing.
 - 2) This will perform the same test every day (Monday -Sunday).
 - B. Weekday Exercising
 - 1) The LCD will display DAY (with 1-5) flashing.
 - 2) This will perform the same test every week day (Monday-Friday).
 - C. Weekend Exercising
 - 1) The LCD will display DAY (with 6-7) flashing.
 - 2) This will perform the same test every weekend day (Saturday-Sunday).
 - D. Customized Exercising
 - 1) The LCD will Display ANY DAY flashing.

- 2) This will perform a test on any day that is programmed.
7. Once the program option is highlighted on the LCD, press the (OK) button.
8. For Daily, weekday and weekend exercise programming, perform the following:
 - A. Press the (-) or (+) buttons to set the hour you want the exercise to turn on.
 - B. Once the correct hour is flashing, press the (OK) button.
 - C. Press the (-) or (+) buttons to set the minute of the hour that you want the exercise to turn on.
 - D. Once the correct minute is flashing, press the (OK) button.
 - E. Press the (-) or (+) buttons to set the hour you want the exercise to turn off.
 - F. Once the correct hour is flashing, press the (OK) button.
 - G. Press the (-) or (+) buttons to set the minute of the hour that you want the exercise to turn off.
 - H. Once the correct minute is flashing, press the (OK) button.
9. For customized exercising, perform the following:
 - A. Press the (-) or (+) buttons to set the hour you want the exercise to turn on.
 - B. Once the correct hour is flashing, press the (OK) button.
 - C. Press the (-) or (+) buttons to set the minute of the hour that you want the exercise to turn on.
 - D. Once the correct minute is flashing, press the (OK) button.
 - E. Press the (-) or (+) buttons to set the hour you want the exercise to turn off.
 - F. Once the correct hour is flashing, press the (OK) button.
 - G. Press the (-) or (+) buttons to set the minute of the hour that you want the exercise to turn off.
 - H. Once the correct minute is flashing, press the (OK) button.
 - I. Press the (-) or (+) buttons to move the flashing cursor and set the day of the week you want the exercise.
 - J. Once the flashing cursor is above the day you want selected for exercise, press the (OK) button.
 - K. Continue steps I – J until all of the days are selected you want to run the exercise.
 - L. Press the (-) or (+) buttons until the flashing cursor is below the number 1 (designating Monday).
 - M. Once the flashing cursor is below the day you want to select to end the exercise cycle, press the (OK) button.
 - N. Continue step M until all of the days are selected to end the exercise cycles in the program, press the (OK) button.
 - O. The LCD will toggle the display between showing the program and saying prog OK:
 - 1) If the program is what is desired, press the (OK) button to save the program.
 - 2) If the program is not what is desired, press the (MENU) button to reprogram the exercise program.



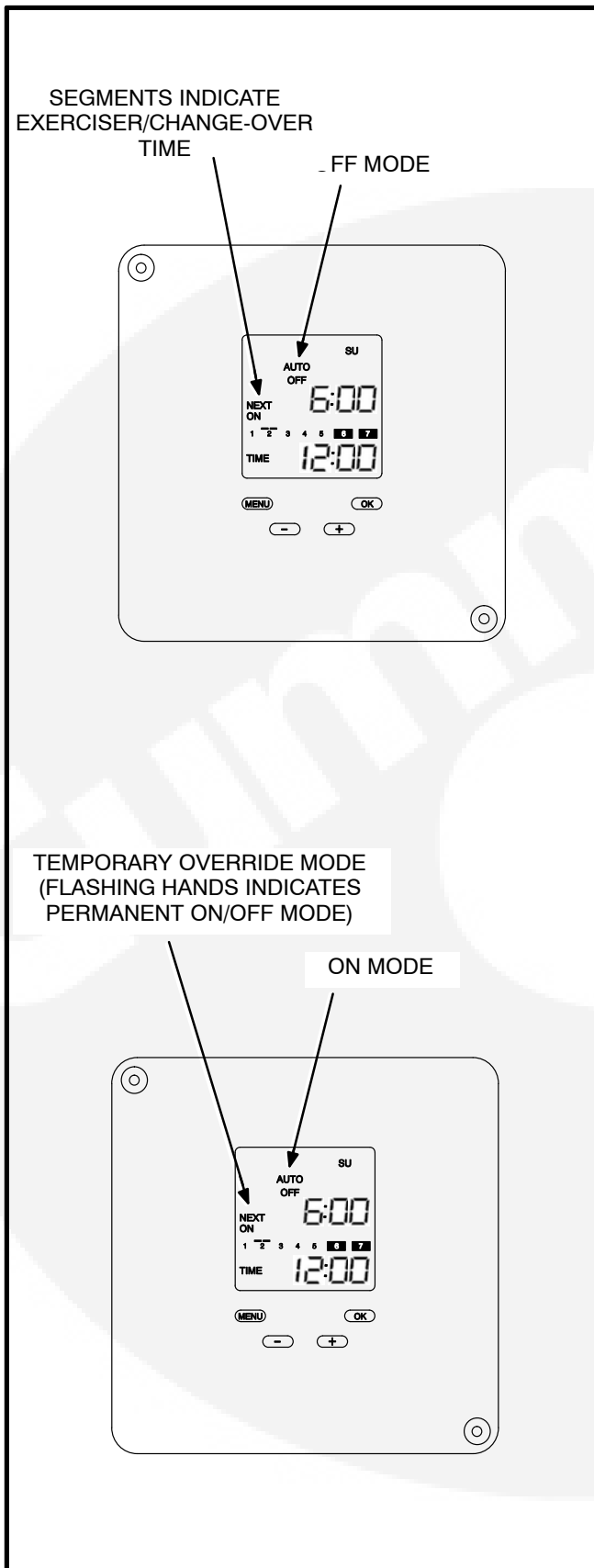

FIGURE 2. CLOCK ON/OFF MODE

To Set The Change-Over Time:

1. Press the (MENU) button once, the LCD display will show SET, PROG, and MODE for options. If the word PROG is flashing, press the (OK) button.
2. The LCD display will show PRO with NEW MODIFY and TEST for options. If PROG is flashing, press the (+) button once to make NEW flash.
3. Once the NEW is flashing, press the (OK) button.
4. The LCD will then display the amount of currently available programs that can be created.
 - A. The LCD will show FREE XX PR (which means you have space for XX programs to be created).
5. Once the LCD displays FREE XX PR, press the (OK) button.
6. Press the (-) or (+) buttons to choose between the program options.
 - A. Daily Exercising
 - 1) The LCD will display DAY (with 1-7) flashing.
 - 2) This will perform the same test every day (Monday - Sunday).
 - B. Weekday Exercising
 - 1) The LCD will display DAY (with 1-5) flashing.
 - 2) This will perform the same test every week day (Monday-Friday).
 - C. Weekend Exercising
 - 1) The LCD will display DAY (with 6-7) flashing.
 - 2) This will perform the same test every weekend day (Saturday-Sunday).
 - D. Customized Exercising
 - 1) The LCD will Display ANY DAY flashing.
 - 2) This will perform a test on any day that is programmed.
7. Once the program option is highlighted on the LCD, press the (OK) button.
8. For Daily, weekday and weekend exercise programming, perform the following:
 - A. Press the (-) or (+) buttons to set the hour you want the exercise to turn on.
 - B. Once the correct hour is flashing, press the (OK) button.
 - C. Press the (-) or (+) buttons to set the minute of the hour that you want the exercise to turn on.

- D. Once the correct minute is flashing, press the (OK) button
 - E. Press the (-) or (+) buttons to set the hour you want the exercise to turn off.
 - F. Once the correct hour is flashing, press the (OK) button.
 - G. Press the (-) or (+) buttons to set the minute of the hour that you want the exercise to turn off.
 - H. Once the correct minute is flashing, press the (OK) button.
9. For customized exercising, perform the following:
- A. Press the (-) or (+) buttons to set the hour you want the exercise to turn on.
 - B. Once the correct hour is flashing, press the (OK) button.
 - C. Press the (-) or (+) buttons to set the minute of the hour that you want the exercise to turn on.
 - D. Once the correct minute is flashing, press the (OK) button.
 - E. Press the (-) or (+) buttons to set the hour you want the exercise to turn off.
 - F. Once the correct hour is flashing, press the (OK) button.
 - G. Press the (-) or (+) buttons to set the minute of the hour that you want the exercise to turn off.
 - H. Once the correct minute is flashing, press the (OK) button.
 - I. Press the (-) or (+) buttons to move the flashing cursor and set the day of the week you want the exercise.
 - J. Once the flashing cursor is above the day you want selected for exercise, press the (OK) button.
 - K. Continue steps I – J until all of the days are selected you want to run the exercise
 - L. Press the (-) or (+) buttons until the flashing cursor is below the number 1 (designating Monday).
 - M. Once the flashing cursor is below the day you want to select to end the exercise cycle, press the (OK) button.
 - N. Continue step M until all of the days are selected to end the exercise cycles in the program, press the (OK) button.
 - O. The LCD will toggle the display between showing the program and saying prog Ok:
 - 1) If the program is what is desired, press the (OK) button to save the program
 - 2) If the program is not what is desired, press the (MENU) button to reprogram the exercise program.

To Check and Modify Programs:

1. Press the (MENU) button once, the LCD display will show SET, PROG, and MODE for options. If the word PROG is flashing, press the (OK) button.
2. The LCD display will show PRO with NEW MODIFY and TEST for options. If PROG is flashing, press the (+) button once to make MODIFY flash.
3. Once the MODIFY is flashing, press the (OK) button.
4. The LCD will then flash the word MODIFY.
5. Press the (-) or (+) buttons until the word MODIFY is flashing on the LCD, press the (OK) button.
6. The screen will flash between the word MODIFY and the initial program.
7. Press the (-) or (+) buttons to choose the program to check and/or modify.
8. Once the program desired is displayed, press the (OK) button.
9. The program selected will now be displayed :
 - A. You will have to repeat the process of setting the exercise time or setting the changeover time as is explained previously in the instructions.
 - B. You will have to continually press the (OK) button until you are returned to the program menu.

To Erase (Clear) A Program:

1. Press the (MENU) button once, the LCD display will show SET, PROG, and MODE for options. If the word PROG is flashing, press the (OK) button.
2. The LCD display will show PRO with NEW MODIFY and TEST for options. If PROG is flashing, press the (+) button once to make MODIFY flash.
3. Once the MODIFY is flashing, press the (OK) button.
4. The LCD will then flash the word MODIFY

5. Press the (-) or (+) buttons until the word DEL ONE or DEL ALL is flashing on the LCD, press the (OK) button.

A. To delete one program:

- 1) Continuing from step 5 above, press the (-) or (+) buttons until the words DEL ONE are displayed.
- 2) Once the words DEL ONE are displayed, press the (OK) button.
- 3) Press the (-) or (+) buttons until the screen flashes between the desired program to delete and the word DELETE.
- 4) Once the desired program is displayed, press the (OK) button.
- 5) The LCD will go through a process of turning the program on and off times into a series of dashes. Once the process is complete, the desired program is deleted.

B. To delete all programs:

- 1) Continuing from step 5 above, press the (-) or (+) buttons until the words DEL ALL are displayed.
- 2) Once the words DEL ALL are displayed, press the (OK) button.
- 3) The LCD screen will return to the PROG menu, and all of the saved programs are deleted.

To Test a Program:

1. Press the (MENU) button once, the LCD display will show SET, PROG, and MODE for options.
2. Press the (-) or (+) button to make the word PROG flash.
3. Once the word PROG is flashing, press the (OK) button.
4. The LCD display will show PRO with NEW MODIFY and TEST for options. Press the (-) or (+) buttons to make the word TEST flash.
5. Once the word TEST is flashing, press the (OK) button.
6. Press the (-) or (+) button to make the word prog or SERIAL flash.
7. If the word prog is selected:
 - A. The screen will show the first program to test (all programs will be shown in order entered)

- B. Press the (OK) button continuously to get to the program you want to test.
- C. Once the program is tested, press the (OK) button.
- D. The LCD will display the word END, press the (OK) button to end testing.

8. If the word SERIAL is selected:

- A. The screen will show the first program to test (all programs will be shown in order entered)
- B. Press the (OK) button continuously to get to the program you want to test.
- C. Once the program is tested, press the (OK) button.
- D. The LCD will display the word END, press the (OK) button to end testing.

Permanent On/Off Mode:

Note: This feature is not used for any current applications. It is described here to help recognize and get out of this mode.

1. If the LCD main screen displays the word PERM, perform the following steps:
 - A. Press the (MENU) button once, the LCD display will show SET, PROG, and MODE for options.
 - B. Press the (-) or (+) button to make the word MODE flash.
 - C. Once the word MODE is flashing, press the (OK) button.
 - D. Press the (-) or (+) button to make the AUTO flash.
 - E. If the word AUTO is flashing, press the (OK) button.

This will revert the clock from the permanent mode to the auto mode (which is the mode that we use).

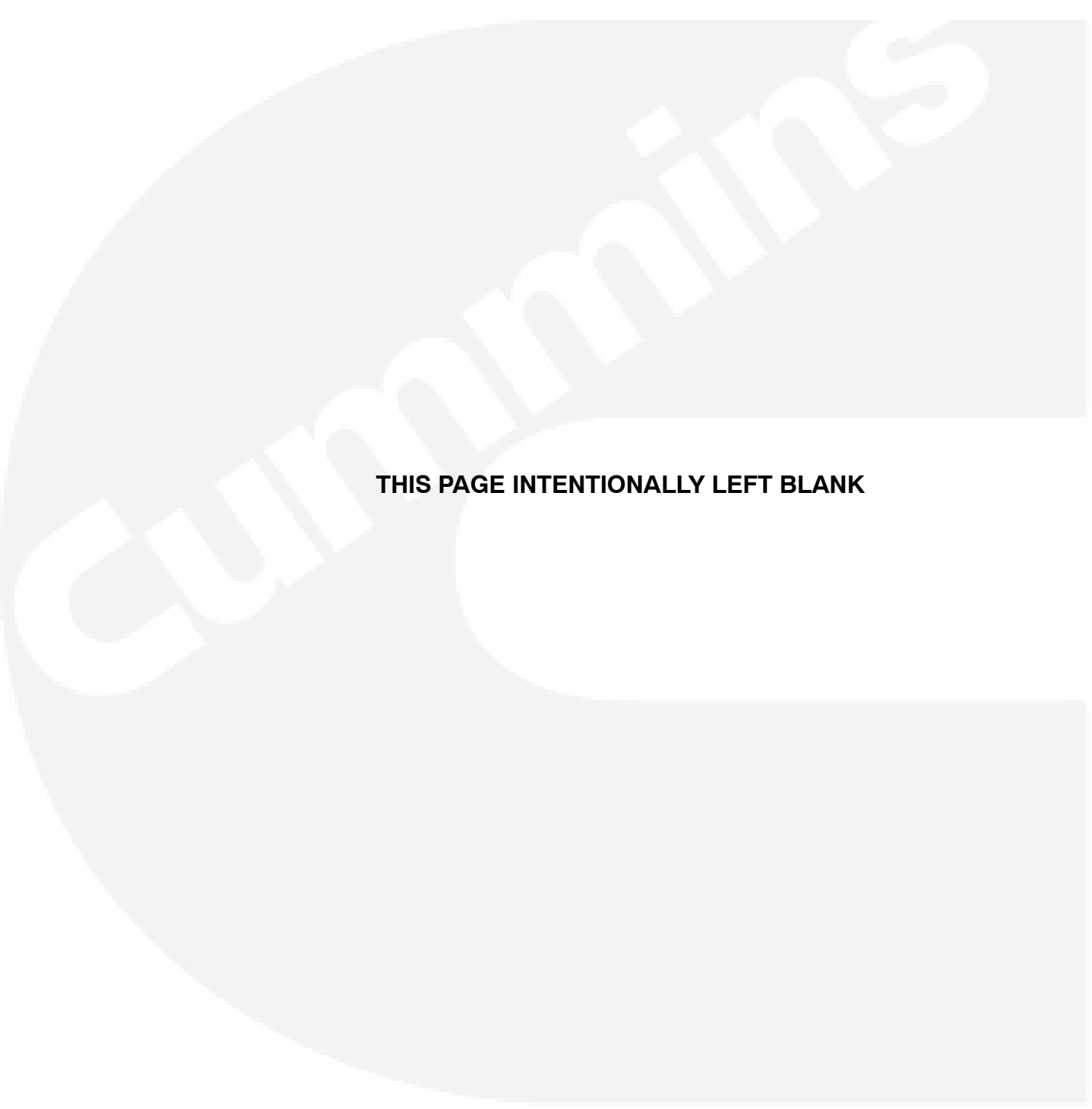

THIS PAGE INTENTIONALLY LEFT BLANK



Table of Contents

SECTION	TITLE	PAGE
1	INTRODUCTION	1-1
	Operator's Manual	1-1
	Transfer Switch Application	1-1
	Automatic Transfer Switches	1-1
	Model Identification	1-2
	How to Obtain Service	1-2
2	DESCRIPTION	2-1
	Cabinet	2-1
	Transfer Switch	2-2
	Electronic Control System	2-3
3	OPERATION	3-1
	Automatic Operation	3-1
	Manual Operation	3-1
	Generator Set Exercise	3-2
	Generator Set Start Test	3-3
	With-Load Standby System Test	3-3
	Preventive Maintenance	3-4
4	TROUBLESHOOTING	4-1
	Power Outage Occurs but Generator Set Does Not Start	4-1
	Generator Set Starts During Normal Power Service	4-1
	Generator Set Does Not Exercise (If Equipped With Exerciser)	4-2
	After a Power Failure, Generator Set Starts but Does Not Assume Load	4-2
	After Power Returns, Transfer Switch Does Not Return to Normal Position	4-3
	Generator Set Continues to Run After Retransfer of Load to Normal Power	4-3
	Battery Charger Fails to Charge (If Equipped)	4-3
	Battery Loses Water	4-3
	Battery Loses Charge	4-3

⚠ WARNING

INCORRECT SERVICE OR REPLACEMENT OF PARTS CAN RESULT IN DEATH, SEVERE PERSONAL INJURY, AND/OR EQUIPMENT DAMAGE. SERVICE PERSONNEL MUST BE QUALIFIED TO PERFORM ELECTRICAL AND/OR MECHANICAL SERVICE.

Safety Precautions

This manual includes the following symbols to indicate potentially dangerous conditions. Read the manual carefully and know when these conditions exist. Then take the necessary steps to protect personnel and the equipment.

⚠ DANGER *This symbol warns of immediate hazards that will result in severe personal injury or death.*

⚠ WARNING *This symbol refers to a hazard or unsafe practice that can result in severe personal injury or death.*

⚠ CAUTION *This symbol refers to a hazard or unsafe practice that can result in personal injury or product or property damage.*

AC and DC voltages in the transfer switch components present serious shock hazards that can result in severe personal injury or death. Read and follow these instructions.

Keep the transfer switch cabinet closed and locked. Make sure only authorized personnel have the cabinet and operational keys.

Due to the serious shock hazard from high voltages within the cabinet, all service and adjustments to the transfer switch must be performed only by an electrician or authorized service representative.

If the cabinet must be opened for any reason:

1. Move the operation selector switch on the generator set to Stop.
2. Disconnect the starting batteries of the generator set. (Remove the negative [-] lead first to prevent arcing from igniting explosive battery gas.)
3. Remove AC power to the automatic transfer switch. If the instructions require otherwise, use extreme caution due to the danger of shock hazard.

Place rubber insulative mats on dry wood platforms over metal or concrete floors when working on any electrical equipment. Do not wear damp clothing (particularly wet shoes) or allow skin surfaces to be damp when handling any electrical equipment.

Jewelry is a good conductor of electricity and should be removed before working on the electrical equipment.

Do not work on this equipment when mentally or physically fatigued, or after consuming alcohol or any drug that makes the operation of equipment unsafe.



1. Introduction

OPERATOR'S MANUAL

This manual provides information necessary for operation of 1200- to 3000-ampere, utility-to-generator set transfer switches.

TRANSFER SWITCH APPLICATION

Transfer switches are an essential part of a building's standby or emergency power system. The Normal power source, commonly the utility line, is backed up by an Emergency power source, often an electric generating set. A transfer switch supplies the electrical load with power from one of these two power sources.

The load is connected to the common of the transfer switch (Figure 1-1). Under normal conditions, the load is supplied with power from the Normal source (as illustrated). If the Normal power source is interrupted, the load is transferred to the Emergency power source. When Normal power returns, the load is retransferred to the Normal power source. The transfer and retransfer of the load are the two most basic functions of a transfer switch.

AUTOMATIC TRANSFER SWITCHES

Automatic transfer switches, capable of automatic operation without operator involvement, perform the following basic functions:

1. Sense the interruption of the Normal power source.
2. Send a start signal to the generator set (Emergency power source).
3. Sense that Emergency power is available.
4. Transfer the load to the Emergency power source.
5. Sense the return of the Normal power source.
6. Retransfer the load to the Normal power source.
7. Send a stop signal to the generator set.

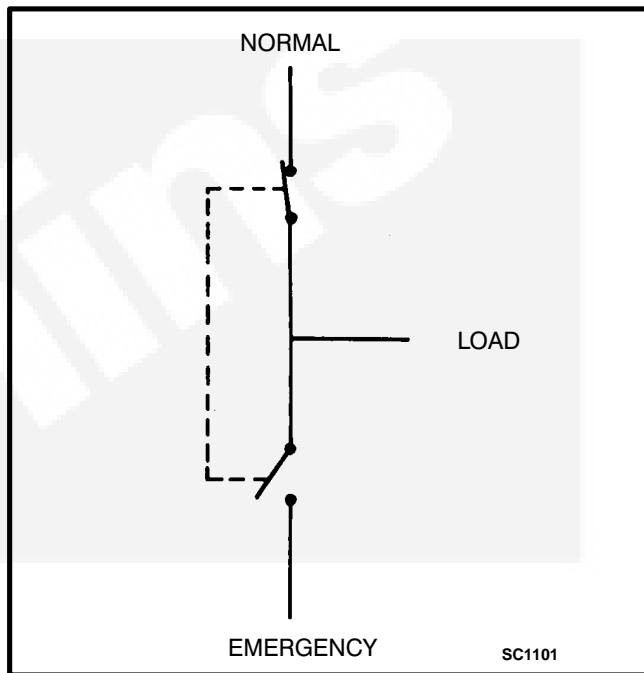

FIGURE 1-1. LOAD TRANSFER SWITCH (TYPICAL FUNCTION)

MODEL IDENTIFICATION

Identify your model by referring to the Model and Specification number as shown on the nameplate. Electrical characteristics are shown on the lower portion of the nameplate, which is located on the cabinet door.

If it is necessary to contact a dealer or distributor regarding the transfer switch, always give the complete Model, Specification, and Serial number. This information is necessary to properly identify your unit among the many types manufactured.

HOW TO OBTAIN SERVICE

When the transfer switch requires servicing, contact your nearest dealer or distributor. Factory-trained Parts and Service representatives are ready to handle all your service needs.

If unable to locate a dealer or distributor, consult the Yellow Pages. Typically, our distributors are listed under:

GENERATORS-ELECTRIC,
ENGINES-GASOLINE OR DIESEL, OR
RECREATIONAL VEHICLES-EQUIPMENT,
PARTS AND SERVICE.

For the name of your local Cummins®/Onan® or Onan-only distributor in the United States or Canada, call 1-800-888-ONAN. (This automated service utilizes touch-tone phones only.) By entering your area code and the first three digits of your local telephone number, you will receive the name and telephone number of the distributor nearest you.

For the name of your local Cummins-only distributor, or if you need more assistance, please call Onan Corporation, 1-612-574-5000, 7:30 AM to 4:00 PM, Central Standard Time, Monday through Friday.

When contacting your distributor, always supply the complete Model Number and Serial Number as shown on the nameplate.

Cummins is a registered trademark of Cummins Engine Company.

Onan is a registered trademark of Onan Corporation.



2. Description

Automatic transfer switches control transfer of the load to the Normal power source or to the Emergency power source (generator set) without operator involvement.

CABINET

The standard cabinet (Figure 2-1) meets the requirements for a UL Type 1 cabinet. This type is designated as a general-purpose, indoor cabinet.

Indicator Lamps

There are four indicator lamps on the cabinet door. The Normal Available and Emergency Available lamps are lit whenever their corresponding power sources (utility or generator set) are producing power. These two lamps can be lit simultaneously.

The Normal Connected lamp is lit when the automatic transfer switch is in the normal position. The Emergency Connected lamp is lit when the automatic transfer switch is in the emergency position.

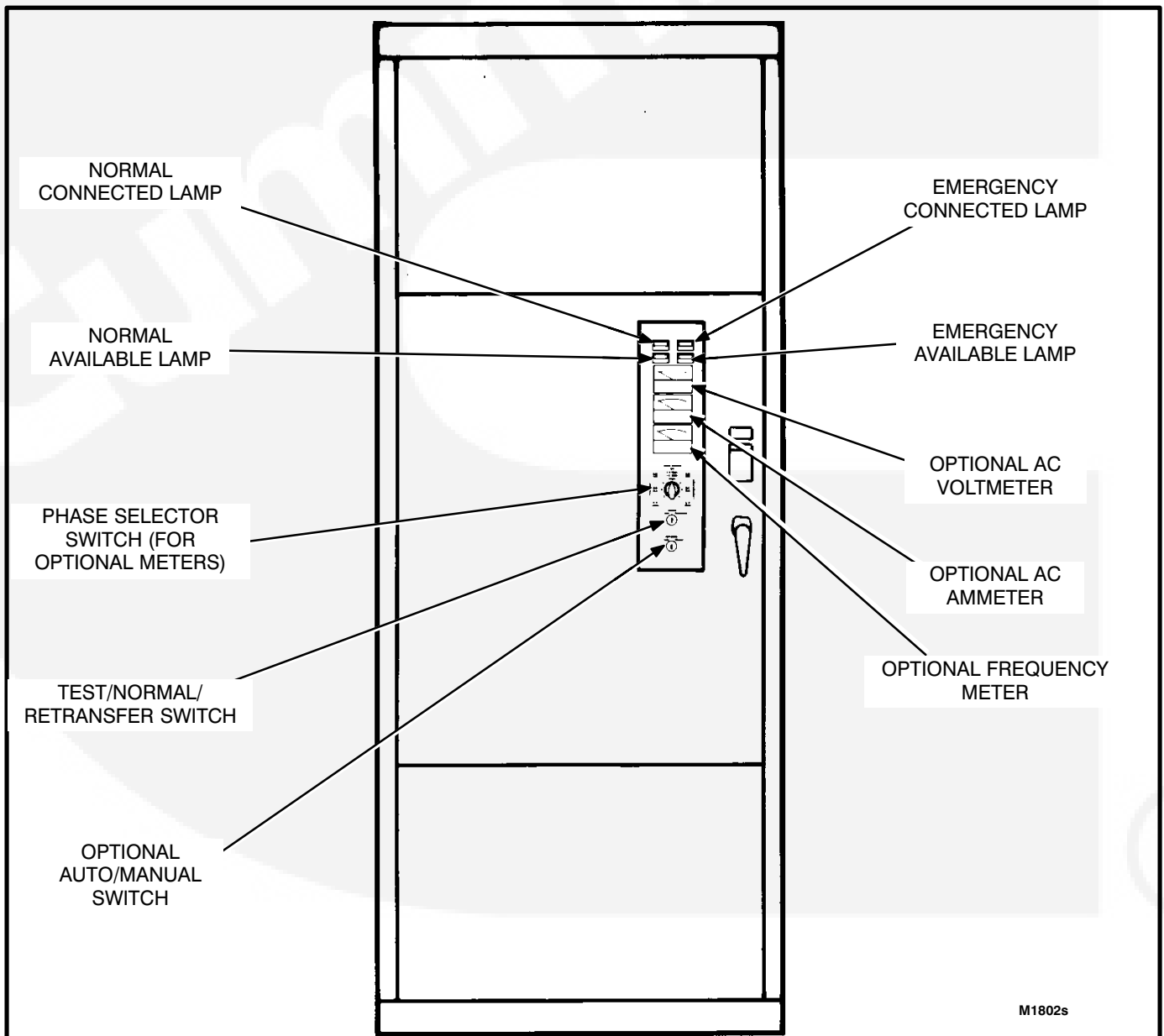

FIGURE 2-1. CABINET WITH OPTIONS

Test/Normal/Retransfer Switch

This switch has three positions. In the Normal position, the transfer switch is set for automatic operation. Moving the switch to Test sends a start signal to the generator set. After the transfer time delay, the generator set will assume the load—provided that the Test With/Without Load switch (Figure 2-2) is in the With Load position.

Moving the switch to Normal causes the load to retransfer to the Normal power source after the retransfer time delay. To avoid the delay and cause a fast retransfer of load to the Normal power source, move the switch to the Retransfer position.

Optional Meter Package

The optional meter package includes an AC ammeter, an AC voltmeter, a frequency meter, and a phase selector switch.

AC Voltmeter: The voltmeter measures line-to-line voltage of the selected power source.

AC Ammeter: The ammeter measures the line currents of the load.

Frequency Meter: This meter measures the output frequency of the selected power source in hertz.

Phase Selector Switch: This switch is used to select the source and phase to be measured.

Optional Auto/Manual Switch

The Auto/Manual switch is used to enable or disable the automatic retransfer function. This switch has two positions. In the Auto position, normal automatic retransfer is enabled. In the Manual position, automatic retransfer (from a functioning generator set back to utility power) is disabled; only manual retransfer (using the Test/Normal/Retransfer switch) is possible. In the event of generator set failure, however, the Power Sentry control logic will ignore the Auto/Manual switch and initiate retransfer to utility power.

TRANSFER SWITCH

The transfer switch (Figure 2-2) opens and closes the contacts that transfer the load between Normal and Emergency power. The transfer switch is mechanically interlocked to prevent simultaneous closing to both power sources. The main parts of the transfer switch discussed here are the contact

assemblies, linear actuators, Motor Disconnect switch, and auxiliary contacts.

Contact Assemblies

The transfer switch either has three or four poles. Three pole transfer switches are provided with a neutral bar. The contact assemblies make and break the current flow. When closed to either the Normal or the Emergency power source, the contacts are mechanically held. A mechanical interlock prevents them from closing to both power sources at the same time.

Linear Actuators

The linear actuators are the devices that move the contact assemblies between the Normal power source and the Emergency power source. Linear actuator operation is initiated automatically with automatic transfer switches. Manual operation of the transfer switch (using the Test/Normal/Retransfer switch) is also possible. Refer to the Operation section.

CAUTION *Do not initiate rapid cycling of the linear actuators. Rapid switching will cause actuator failure. The maximum allowable cycle rate for the linear actuators is one cycle in two minutes.*

Motor Disconnect Switch

The Motor Disconnect toggle switch, on the accessory control panel, enables and disables the linear actuators. Place the switch in the Auto position to enable the linear actuators. Place the switch in the Off position to disable the linear actuators.

Auxiliary Contacts

Auxiliary contacts are provided on the Normal and Emergency sides of the transfer switch. They are actuated by operation of the transfer switch during transfer and retransfer. The Normal side auxiliary contact switch is actuated when the transfer switch is in the Normal position. The Emergency side auxiliary contact switch is actuated when the transfer switch is in the Emergency position. The auxiliary contacts have current ratings of 10 amperes at 250 VAC. The contacts are wired to terminal block TB1.

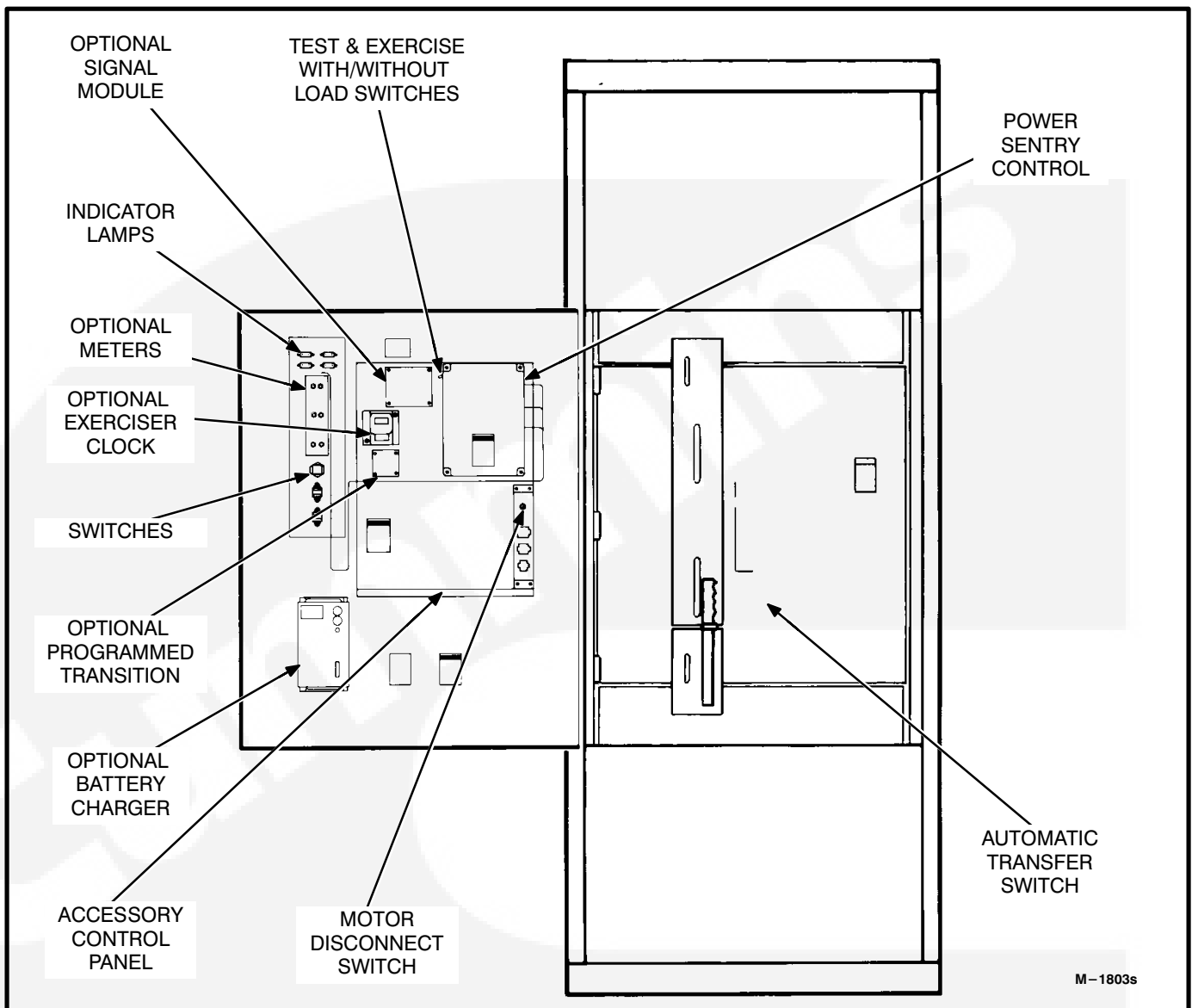

FIGURE 2-2. INTERIOR/COMPONENTS

ELECTRONIC CONTROL SYSTEM

This section describes the standard and optional components of the electronic control system.

⚠️WARNING *Improper calibration or adjustment of electronic control modules can cause death, severe personal injury, and equipment or property damage. Calibration and adjustment of these components must be performed by technically qualified personnel only.*

All calibration and adjustment procedures are described in the Installation manual (which was shipped with the transfer switch) and in the Service manual (which is available through your distributor).

The most important component of the electronic control system is the Power Sentry control (Figure 2-2). The Power Sentry includes voltage sensing

circuits, time delay circuits and control relays. There are also several adjustment potentiometers and indicator lamps on the Power Sentry. The adjustments must be performed only by qualified service personnel.

⚠️WARNING *Accidental actuation of the linear actuators could cause severe personal injury. Disable the actuators, as described below, before making any adjustments.*

Place the Motor Disconnect Switch (Figure 2-2) in the Off position when making adjustments. Return the switch to the Auto position after adjustments are completed.

⚠WARNING *AC power within the cabinet and the rear side of the cabinet door presents a shock hazard that can cause severe personal injury or death. Use extreme caution to avoid touching electrical contacts when the cabinet door is open.*

Power Sentry Time Delays

Start Time Delay: This delay is adjustable from 0 to 15 or (optionally) from 0 to 90 seconds. This brief time delay prevents generator set starting during power interruptions of short duration. Timing starts the moment of Normal (utility) power interruption. If the duration of interruption exceeds the delay time, the control system signals the generator set to start.

To set this time delay, align the slot on the potentiometer with the desired marking on the Power Sentry cover.

Stop Time Delay: This delay is adjustable from 0 to 10 minutes. It begins timing when the load is retransferred to the Normal power source. At the end of the delay, the stop signal is sent to the generator set. This time delay allows the generator set to cool down at no load before stopping.

To set this time delay, align the slot on the potentiometer with the desired marking on the Power Sentry cover.

Transfer Time Delay: This delay begins when generator voltage and frequency reach the settings of the control. After the delay, the transfer switch transfers the load to the Emergency power source. This brief time delay allows the generator set to stabilize before the load is applied. It has an adjustable range of 0 to 120 seconds.

To set this time delay, align the slot on the potentiometer with the desired marking on the Power Sentry cover.

Retransfer Time Delay: This delay begins the moment Normal line voltage and frequency return. After the delay, the transfer switch can retransfer the load to the Normal source. The delay allows the Normal source to stabilize before retransfer. It has an adjustable range of 0 to 30 minutes.

To set this time delay, align the slot on the potentiometer with the desired marking on the Power Sentry cover.

Undervoltage Sensing

Two voltage sensors, one for the Normal side and one for the Emergency side, monitor source voltages for an undervoltage condition and generate signals, which are sent to the time delay module. If, for example, an under-voltage condition is sensed on the Normal source, the voltage sensor module sends a signal to the time delay module that initiates and controls the timing for generator set start and the transfer of load.

The standard transfer switch has undervoltage sensing for all phases of the Normal and Emergency power sources.

Overvoltage and Frequency Sensing Option

Overvoltage and frequency sensing are available as a single option.

Overvoltage Sensing: With optional overvoltage sensing, the Normal and Emergency sources are monitored for an overvoltage condition.

As with the standard undervoltage sensing, the voltage sensors signal the time delay module, which controls the transfer or retransfer sequence.

An adjustable time delay (0 to 120 seconds) overrides momentary overshoots in voltage.

To set this time delay, align the slot on the potentiometer with the desired marking on the Power Sentry cover.

Frequency Sensing: With optional frequency sensing, the Normal and Emergency sources are monitored for variations in frequency. The sensors determine whether the source is within an adjustable bandwidth.

As with the standard undervoltage sensing, the frequency sensors signal the time delay module, which controls the transfer or retransfer sequence.

An adjustable time delay (0 to 15 seconds) allows the control to ignore momentary dips or rises in frequency.

To set this time delay, align the slot on the potentiometer with the desired marking on the Power Sentry cover.

Starting Circuit

The starting circuit is a basic supervisory function of the electronic control. Although the logic is more involved, the starting circuit can be thought of as a single pole, single throw switch. A closed switch signals the generator set to start. An open switch signals the electric generator set to stop.

Programmed Transition Option

The optional Program Transition module (Figure 2-3) is used to introduce a pause during transition. Programmed transition allows the transfer switch to assume a mid-transition position for an adjustable interval of time. In this position, the load is **not** connected to either (Normal or Emergency) power source.

This feature allows residual voltage from inductive loads to decay to an acceptable level before transfer is completed. The length of time that the transfer switch is in the midposition can be adjusted from 0 to 7.5 seconds or 0 to 60 seconds, depending on the timer option. The proper adjustment is a function of the load.

To set the time delay, align the slot on the potentiometer with the desired marking on the faceplate (Figure 2-3).

If a time delay is desired, make sure that the Delay/No Delay switch is in the Delay position.

Signal Module Option

The main function of the optional Signal Module is to delay transfer (or retransfer) for a preset time while operating a signal contact to give warning that a transfer (or retransfer) is about to occur. This option is typically used in elevator applications.

This module also provides four other sets of form C signal contacts.

The Signal Module has one adjustable timer. The Elevator Signal delay controls the timing of two events. It delays transfer/retransfer and energizes the Elevator Transfer Signal relay during the delay period.

This time delay is adjustable over a range of 0 to 50 seconds.

To set the time delay, align the slot on the potentiometer with the desired marking on the faceplate (Figure 2-4).

If a time delay is desired, make sure that the Delay/No Delay switch is in the Delay position.

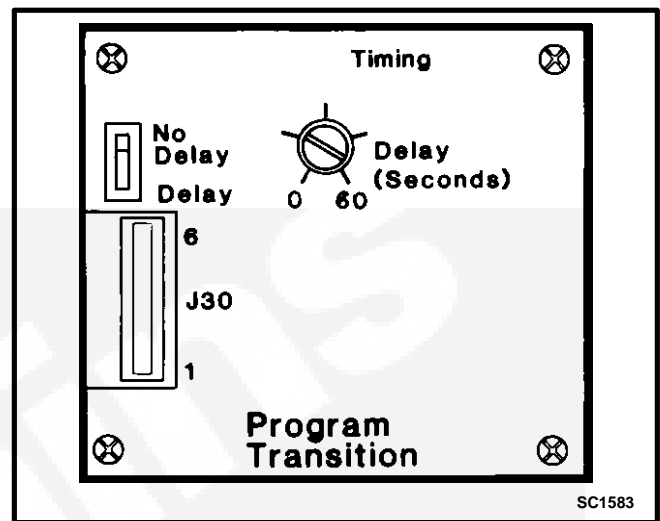

FIGURE 2-3. PROGRAM TRANSITION MODULE

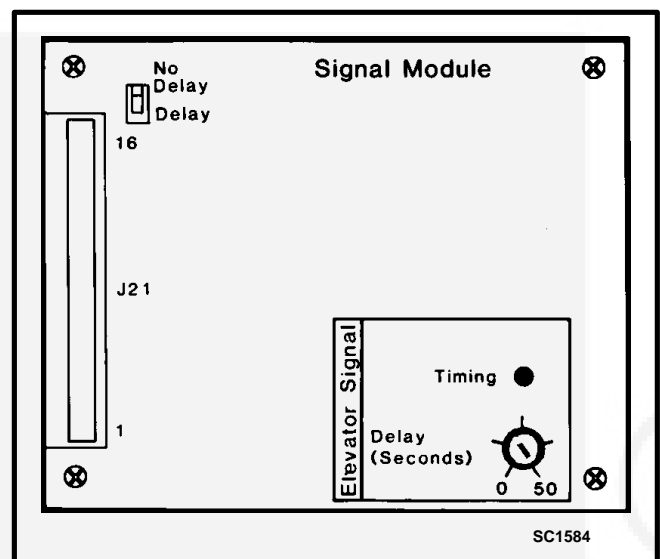

FIGURE 2-4. SIGNAL MODULE

Load Shed Option

The optional Load Shed function is used to disconnect the load from an available Emergency source in order to reduce the power consumed from that source. When the load shed function is initiated, the switch is moved to the neutral position.

The load shed function is initiated by a customer-supplied signal.

When load shedding is in effect, a return of Normal utility power will cause retransfer to the Normal power source.

If the load shed signal is removed before Normal power returns, the switch will transfer back to the Emergency side.

Remote Test Transfer

The transfer switch may be wired with a remote test switch. Closure of a set of contacts across the remote test transfer inputs causes the transfer switch to sense a (simulated) utility power failure and send a start/run signal to the generator set. The load is transferred to the generator set when generator set power becomes available. (Refer to the Installation and Service manuals.)

Float Battery Charger Option

A float-charge battery charger (Figure 2-5) regulates its charge voltage to continuously charge without damage to the battery. As the battery approaches full charge, the charging current automatically tapers to zero amperes or to steady-state load on the battery.

There are two chargers available. One battery charger is rated for 10 amperes at 12 or 24 VDC. The other battery charger is rated for 2 amperes at 12 or 24 VDC.

The 2-ampere battery charger has an ammeter to indicate charging current and a fuse to protect the battery charger circuit.

The 10-ampere battery charger has three fuses (two on the AC input and one on the DC output), three fault display LEDs, and an ammeter for indication of charging current.

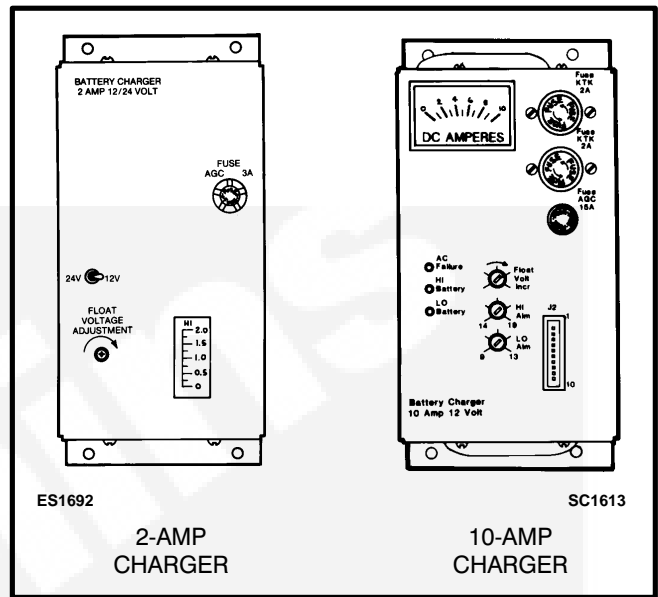

FIGURE 2-5. BATTERY CHARGER

On the 10-ampere charger, three sets of (form C) alarm contacts (corresponding to the three fault LEDs) are also available. Using an optional alarm contact harness, these contacts can be wired by the installer to activate other audible or visual alarms.

Under normal operating conditions, the Low Bat and AC Fail relays are energized and the High Bat relay is de-energized. In response to a Low Bat or AC Fail condition, the appropriate normally energized relay (Low Bat or AC Fail) drops out. In response to a High Bat condition, the normally de-energized High Bat relay is energized.

Auxiliary Relays Option

Optional auxiliary relays provide contacts for energizing external alarms, remote indicators, and control equipment such as louver motors and water pumps.

Alarm Module Option

The optional alarm module (Figure 2-6) provides an audible indication that the transfer switch has transferred to the emergency power source.

A push button on the alarm module provides a means to silence the horn.

The Alarm lamp indicates that the transfer switch is in the Emergency Connected position. If the horn is silenced, the Horn Silenced lamp will also light. Both lamps will stay lit until the transfer switch moves from the Emergency Connected position to the disconnected (neutral) or Normal Connected position.

Exerciser Clock Option

The exerciser clock initiates generator set start/run cycles at programmable intervals and for programmable durations. It is a 7-day, 24-hour clock that can store and execute up to ten start/stop programs (exercise cycles).

Programming the exerciser clock requires setting the time of day and entering the exercise start and stop times.

Refer to the circled numbers in Figure 2-7 when reading the following instructions.

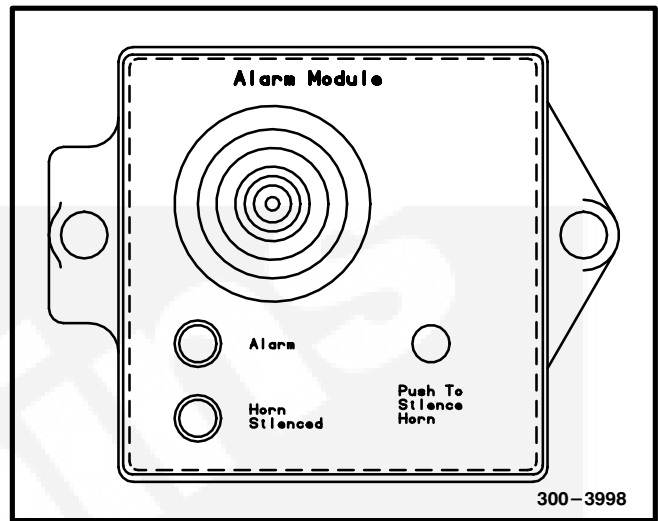

FIGURE 2-6. ALARM MODULE

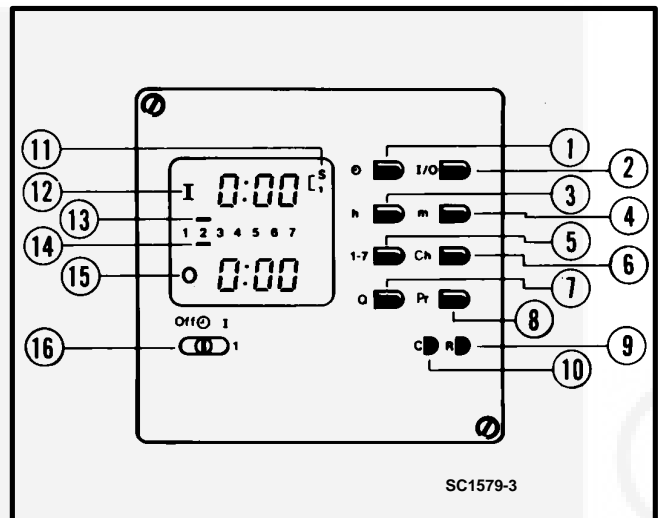

FIGURE 2-7. EXERCISER CLOCK

To set the time of day:

1. If you are performing installation and setup, press the R button (9) with the tip of a ball point pen to reset all memory. Do not press the R button if you are only changing the time of day.
2. Press the clock button (1).
3. Press the h button (3) to set the hour of the day. The clock uses 24-hour (military) time.
4. Press the m button (4) to set the minutes of the hour.
5. Press the 1-7 button (5) to advance the indicator bar over the desired day number. (Use the 1 to represent Sunday.)
6. Press the Pr button (8) to enter the time.

To set the exercise start time:

1. Slide the output selector switch (16) to the center position. The output selector switch has three positions. The Off position overrides the program and causes an exercise stop. The I position overrides the program and causes an exercise start. The center position selects program control.
2. Press the I/O button (2). An "I" (12) appears in the upper display window. The "I" is a symbol for start time.
3. Press the h button (3) to set the start hour.
4. Press the m button (4) to set the start minute.
5. Press the 1-7 button (5) to advance the indicator bar (13) from 1 to 7 and back to 1. For each day to be selected for exercise, press the Q button (7) when the indicator is over the desired day number. (1 represents Sunday.)

To set the exercise stop time:

1. Press the I/O button (2). An "O" (15) appears in the lower left display window. The "O" is a symbol for stop time.
2. Press the h button (3) to set the stop hour.
3. Press the m button (4) to set the stop minute.
4. Press the 1-7 button (5) to advance the indicator bar (14) from 1 to 7 and back to 1. For each start time (selected in step 5 above), there must be a corresponding stop time. A program can start on day 2, pass through midnight, and stop on day 3 (for example); but there must be a stop time for every start time. Press the Q button (7) when the indicator is under the desired day number.

5. To enter the complete start/stop program, press the Pr button (8). If all program requirements have been satisfied, the display returns to the time of day. If the program requirements are not met, the display of the section that needs correction flashes on and off.

To enter more programs, repeat the two 5-step procedures. A maximum of ten programs can be entered. (The same ten programs can be repeated each day.)

The word "Full" appears in the display when the memory is full.

If the I/O button (2) is pressed and no program is to be entered, press the Ch button (6) and then the Pr button (8) to get out of the program mode.

To check the programs:

1. Press the Ch button (6). An "I" (12) and an "O" (15) are displayed.
2. Press the Ch button (6) again. The start and stop information for the first program is displayed.
3. Continued pressing of the Ch button (6) causes the display to sequence through all of the programs in memory. If ten programs have been entered, the word "Full" appears after the tenth program display.
4. Press the Pr button (8) to return to the time-of-day display.

To change (edit) a program:

1. Press the Ch button (6) until the program you want to change appears in the display window.
2. Press the I/O button (2) to select start or stop time.
3. Press the h (3), m (4), or 1-7 (5) and Q (7) buttons to change the hour, minute, or day.
4. Press the Pr button (8) to enter the edited program and return to the time-of-day display.

To erase (clear) a program:

1. Press the Ch button (6) until the program to be erased is displayed.
2. Press the C button (10) with a ball point pen to clear the program.
3. Press the Pr button (8) to return to the time-of-day display.

Phase Sequence/Balance Monitor Option

The optional phase sequence/balance monitor (Figure 2-8) is connected to—and senses—A, B, and C phases of utility power. If there is an over- or undervoltage, a phase reversal, a loss of one phase, or an unbalanced voltage condition; a normally energized relay drops out, closing a set of contacts. When these contacts close, the generator set start/transfer of load sequence is initiated.

Five LEDs indicate normal operation or fault conditions. The Relay Energized LED is lit during normal operation. Three potentiometers permit setting the percent of voltage unbalance, the normal system voltage, and the relay dropout time delay.

The relay dropout delay applies only to over/undervoltage and voltage unbalance. In the event that a phase reversal or loss of one phase is sensed, relay dropout occurs within 100 milliseconds (maximum). There is NO relay dropout delay when a phase reversal or loss of phase is sensed.

- Overvoltage dropout occurs at normal voltage +10% ($\pm 2\%$).
- Undervoltage dropout occurs at normal voltage -10% ($\pm 2\%$).
- Dropout time delay range is 2 to 20 seconds.
- Percent voltage unbalance range is 2 to 6% on 240- and 480-volt units.
- Percent voltage unbalance range is 2 to 8% on 380-volt units.

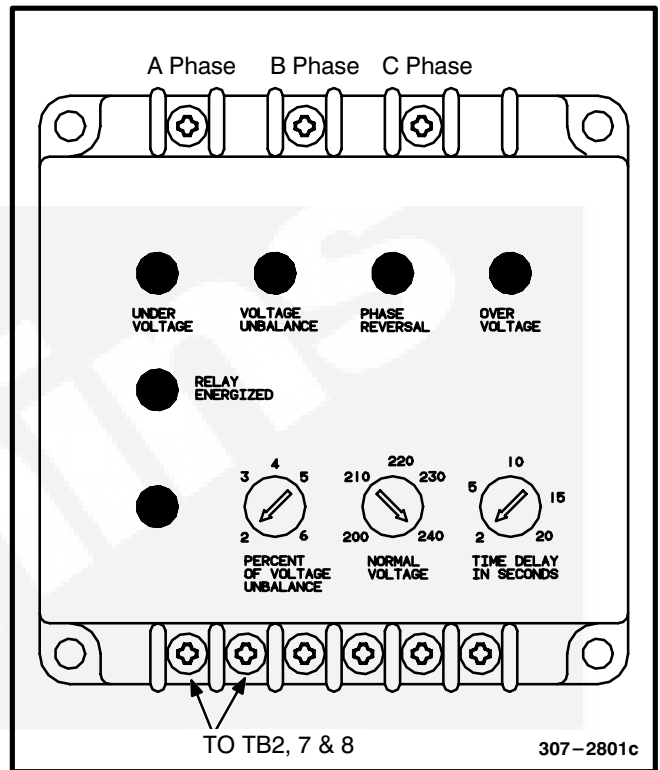
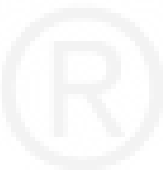

FIGURE 2-8. PHASE SEQUENCE BALANCE MONITOR



3. Operation

AUTOMATIC OPERATION

The automatic transfer switch is set for automatic operation by placing control switches in the positions given below. The generator set must also be set for automatic operation.

- **Motor Disconnect Switch:**
Auto position
- **Test/Normal/Retransfer switch:**
Normal position.
- **Operation selector switch (engine control):**
Remote position.

MANUAL OPERATION

The transfer switch has operator handles that are intended for maintenance use only. Manual operation must be performed by qualified personnel under **NO-LOAD CONDITIONS ONLY**.

⚠WARNING *Manual operation of the transfer switch under load presents a shock hazard that can cause severe personal injury or death. For this reason, do not attempt to perform manual operation of the transfer switch when it is under load. Follow the “Safety Related Work Practices” listed in NFPA 70E.*

Manual Transfer to the Emergency Source

If you determine that the Emergency power source is available but the transfer switch will not automatically transfer (refer to the *Troubleshooting* section), perform this procedure to manually transfer to the Emergency source.

1. Open the Emergency and Normal disconnect switches or breakers that feed the transfer switch. If there is no Emergency side disconnect, then turn off the generator set.
2. When you are certain that neither Normal nor Emergency power is present at the transfer switch, open the transfer switch cabinet door and turn the Motor Disconnect switch to Off.

⚠WARNING *Manual operation of the transfer switch under load presents a shock hazard that can cause severe personal injury or death. For this reason, do not attempt to perform manual operation of the transfer switch when it is energized by either Normal or Emergency power sources.*

3. A manual operating handle is provided with the transfer switch. The handle is a steel rod or tube, with a knob or hand grip on one end. On standard transfer switches (Figure 3-1), there are two manual operator slots—one for the Normal contacts and one for the Emergency contacts.

First, insert the handle in the slot for the Normal contacts and open the Normal contacts. Then, insert the handle in the slot for the Emergency contacts and close the Emergency contacts. Be certain to push the handle all the way to the LOCK position. A distinct over-center locking action can be felt. Return the handle to its storage position.

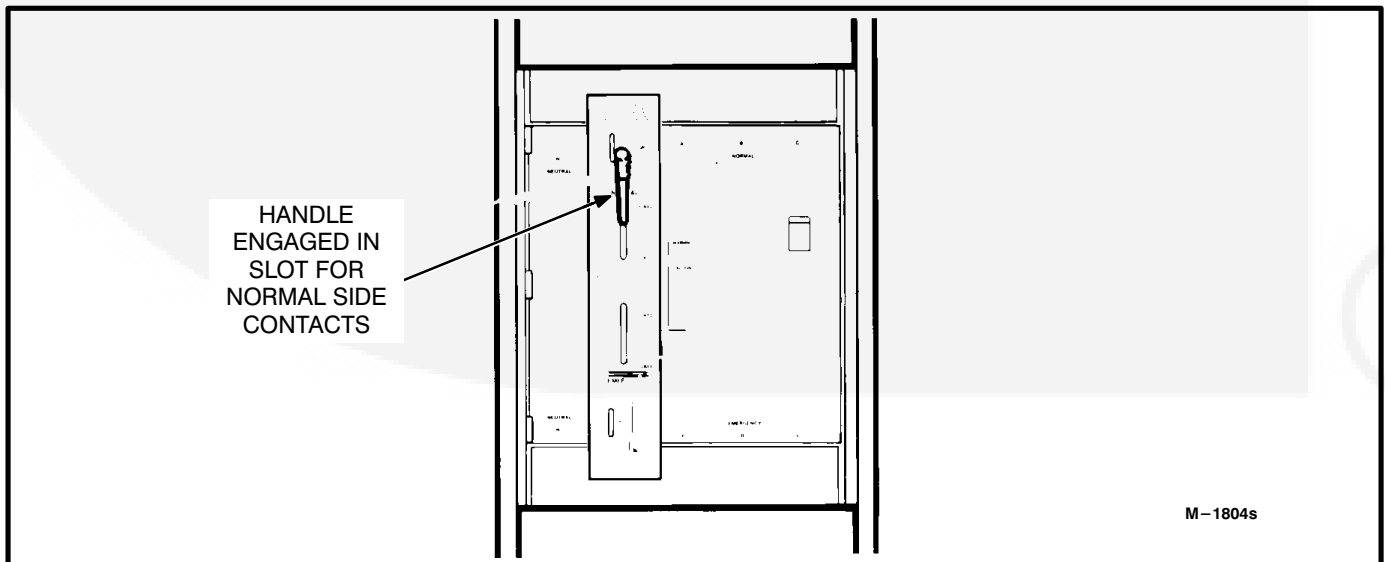

FIGURE 3-1. MANUAL OPERATION

⚠WARNING *Automatic transfer switch operation results in rapid movement of the manual operator mechanism and presents a hazard of severe personal injury if the operator handle is engaged in the mechanism. Remove the handle and place it in its storage position.*

4. After the switch has been transferred to the Emergency source and the operator handle has been removed from the mechanism, close and lock the cabinet door.
5. Close the Emergency disconnect that feeds the transfer switch. Start the generator set if it was previously turned off.
6. If the transfer switch is not functioning correctly, call your dealer or distributor immediately.

Manual Transfer to The Normal Source

If you determine that the Normal power source is available but the transfer switch will not automatically retransfer (refer to the Troubleshooting section), perform this procedure to manually retransfer to the Normal source.

1. Open the Emergency and Normal disconnect switches or breakers that feed the transfer switch. If there is no Emergency side disconnect, then turn off the generator set.
2. When you are certain that neither Normal nor Emergency power is present at the transfer switch, open the transfer switch cabinet door and turn the Motor Disconnect switch to Off.

⚠WARNING *Manual operation of the transfer switch under load presents a shock hazard that can cause severe personal injury or death. For this reason, do not attempt to perform manual operation of the transfer switch when it is energized by either Normal or Emergency power sources.*

3. A manual operating handle is provided with the transfer switch. The handle is a steel rod or tube, with a knob or hand grip on one end. On standard transfer switches (Figure 3-1), there are two manual operator slots—one for the Normal contacts and one for the Emergency contacts.

First, insert the handle in the slot for the Emergency contacts and open the Emergency contacts. Then, insert the handle in the slot for the Normal contacts and close the Normal contacts. Be certain to push the handle all the way

to the LOCK position. A distinct over-center locking action can be felt. Return the handle to its storage position.

⚠WARNING *Automatic transfer switch operation results in rapid movement of the manual operator mechanism and presents a hazard of severe personal injury if the operator handle is engaged in the mechanism. Remove the handle and place it in its storage position.*

4. After the switch has been transferred to the Normal source and the operator handle has been removed from the mechanism, close and lock the cabinet door.
5. Close the Normal disconnect that feeds the transfer switch.
6. If the transfer switch is not functioning correctly, call your dealer or distributor immediately.

GENERATOR SET EXERCISE

Run the generator set for at least 30 minutes once each week, with at least 50 percent load (if possible). If the transfer switch does not have an optional exerciser, use the Test/Normal/Retransfer switch to test the generator set each week.

The optional exerciser has preselected exercise periods and exercises the generator set automatically with or without load, depending on the position of the Exercise With/Without Load switch.

If the Normal power source has an interruption while the generator set is exercising without load, the automatic transfer switch will transfer the load to the generator set.

GENERATOR SET START TEST

⚠WARNING *AC power within the cabinet and the rear side of the cabinet door presents a shock hazard that can cause severe personal injury or death. Use extreme caution to avoid touching electrical contacts whenever the cabinet door is open.*

1. Place the Test With/Without Load selector switch, on the Power Sentry control, in the Without Load position.

The Test With/Without Load selector switch must be in the Without Load position.

2. Close the cabinet door.

⚠WARNING *AC power within the cabinet and the rear side of the cabinet door presents a shock hazard that can cause severe personal injury or death. Close the cabinet door.*

3. Move the Test/Normal/Retransfer switch to Test. The generator set should start and run.
4. At the end of the test period, move the Test/Normal/Retransfer switch to the Normal position. The generator will stop.
5. In anticipation of scheduled or automatic generator set exercise, check that the With/Without Load selector switches are in the desired positions. Refer to *Generator Set Exercise*.
6. Close and lock the cabinet door.

WITH-LOAD STANDBY SYSTEM TEST

⚠WARNING *AC power within the cabinet and the rear side of the cabinet door presents a shock hazard that can cause severe personal injury or death. Use extreme caution to avoid touching electrical contacts whenever the cabinet door is open.*

1. Place the Test With/Without Load selector switch, on the Power Sentry control, in the With Load position.

The Test With/Without Load selector switch must be in the With Load position in order to test with load.

2. Close the cabinet door.

⚠WARNING *AC power within the cabinet and the rear side of the cabinet door presents a shock hazard that can cause severe personal injury or death. Close the cabinet door.*

3. Move the Test/Normal/Retransfer switch to Test. The generator set should start and assume the load after the transfer time delay.

⚠CAUTION *Do not initiate rapid cycling of the linear actuators. Rapid switching will cause actuator failure. The maximum allowable cycle rate for the linear actuators is one cycle in two minutes.*

4. At the end of the test period, move the Test/Normal/Retransfer switch to the Normal position if you want to retransfer load back to the Normal power source after the retransfer time delay. To bypass the retransfer time delay and cause immediate load retransfer, move the Test/Normal/Retransfer switch to Retransfer and release (the switch will return to Normal). The generator will stop after the stop time delay.
5. In anticipation of scheduled or automatic generator set exercise, check that the With/Without Load selector switches are in the desired positions. Refer to *Generator Set Exercise*.
6. Close and lock the cabinet door.

PREVENTIVE MAINTENANCE

Performing the yearly preventive maintenance procedures in Table 3-1 will result in operational reliability of the transfer switch.

The following procedures must only be performed by technically qualified personnel, following the procedures provided in the Service manual (962-0513). **If repair or replacement of components is necessary, call your dealer or distributor.**

⚠WARNING *AC power within the cabinet and the rear side of the cabinet door presents a shock hazard that can cause severe personal injury or death. In addition, incorrect installation, service, or parts replacement can result in severe personal injury, death, and/or equipment damage. Therefore, all corrective service procedures must only be performed by technically qualified personnel, following the procedures provided in the Service manual (962-0513).*

⚠WARNING *The transfer switch presents a shock hazard that can cause severe personal injury or death unless all AC power is removed. Be sure to move the generator set operation selector switch to Stop, disconnect AC line power, disconnect the battery charger from its AC power source, and disconnect the starting battery (negative [-] lead first) before servicing.*

⚠WARNING *Ignition of explosive battery gases can cause severe personal injury. Do not smoke or cause any spark, arc, or flame while servicing batteries.*

TABLE 3-1. ANNUAL PREVENTIVE MAINTENANCE

1. DISCONNECT ALL SOURCES OF AC POWER:

Disconnect both AC power sources from the transfer switch before continuing. Turn the generator set operation selector switch to Stop. (The selector switch is located on the generator set control panel.) ***If there is an external battery charger, disconnect it from its AC power source.*** Then disconnect the set starting battery (negative [-] lead first).

2. CLEAN

- a. Thoroughly dust and vacuum all controls, meters, switching mechanism components, interior buswork, and connecting lugs.
- b. Close the cabinet door and wash **exterior** surfaces with a damp sponge (mild detergent and water). ***Do not allow water to enter the cabinet, especially at meters, lamps, and switches.***

3. INSPECT

- a. Check buswork and supporting hardware for carbon tracking, cracks, corrosion, or any other types of deterioration. If replacement is necessary, call your dealer or distributor.
- b. Check stationary and movable contacts. If contact replacement is necessary, the procedures are described in section 4 of the Service manual (962-0513).
- c. Check system hardware for loose connections. Tighten as indicated in step 4.
- d. Check all control wiring and power cables (especially wiring between or near hinged door) for signs of wear or deterioration.
- e. Check all control wiring and power cables for loose connections. Tighten as indicated in step 4.
- f. Check the cabinet interior for loose hardware. Tighten as indicated in step 4.

4. PERFORM ROUTINE MAINTENANCE

- a. Tighten buswork, control wiring, power cables, and system hardware, as necessary. Hardware torque values are given in section 4 of the Service manual (962-0513). Retorque all cable lug connections. Lug torque requirements are listed in section 1 of the Service manual.
- b. Service or replace the batteries.

5. CONNECT AC POWER AND CHECK OPERATION

- a. Connect the set starting battery (negative [-] lead last). Connect the normal AC power source, enable the backup power source. If applicable, connect power to the battery charger.
- b. Verify proper operation of the battery charger.
- c. Test system operation as described in this section. Close and lock the cabinet door.

4. Troubleshooting

The following procedures describe preliminary troubleshooting checks. If the trouble persists, call your dealer or distributor.

POWER OUTAGE OCCURS, BUT GENERATOR SET DOES NOT START

1. Check the generator set. The operation selector switch on the generator set control panel should be set in the Remote position. Check for fault indicators on the generator set control.

⚠WARNING *AC power within the cabinet and the rear side of the cabinet door presents a shock hazard that can cause severe personal injury or death. Use extreme caution to avoid touching electrical contacts whenever the cabinet door is open.*

2. Start the generator set using its start-stop controls. If it does not crank, check the starting batteries. If it cranks but does not start, check the fuel supply.

⚠WARNING *Ignition of explosive battery gases can cause severe personal injury. Do not smoke or cause any spark or flame while servicing batteries.*

⚠WARNING *Ignition of fuel can cause severe personal injury or death by fire or explosion. Do not permit any flame, cigarette, spark, pilot light, arcing equipment, or other possible source of ignition near the fuel system.*

GENERATOR SET STARTS DURING NORMAL POWER SERVICE

1. The operation selector switch on the generator set control panel should be set in the Remote position.

⚠WARNING *AC power within the cabinet and the rear side of the cabinet door presents a shock hazard that can cause severe personal injury or death. Use extreme caution to avoid touching electrical contacts whenever the cabinet door is open.*

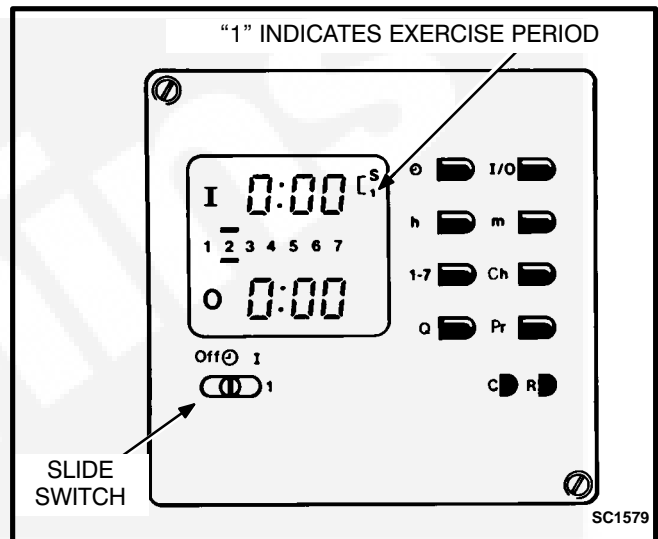

FIGURE 4-1. EXERCISER CLOCK

2. Check the Test/Normal/Retransfer switch to make sure it is in the Normal position.
3. Check the exerciser clock to see if it is in an exercise period. When the exerciser clock is in an exercise period, a “1” appears in the upper right-hand corner of the display window (Figure 4-1). You can view the display by looking through the transparent clock cover. Check that the red slide switch is in the center position.

If the exercise period occurs at an unexpected time or for an excessive duration, refer to the exerciser clock programming procedure or call a service representative.

4. Momentary voltage dips might cause voltage sensors to initiate generator set starting. If the problem persists, call your dealer or distributor.

GENERATOR SET DOES NOT EXERCISE (IF EQUIPPED WITH EXERCISER)

1. The operation selector switch on the generator set control panel should be set in the Remote position.

⚠WARNING *AC power within the cabinet and the rear side of the cabinet door presents a shock hazard that can cause severe personal injury or death. Use extreme caution to avoid touching electrical contacts whenever the cabinet door is open.*

2. Check the exerciser clock to see if it is in an exercise period. When the exerciser clock is in an exercise period, a “1” appears in the upper right-hand corner of the display window (Figure 4-1). You can view the display by looking through the transparent clock cover.
3. Start the generator set using its start-stop controls. If it does not crank, check the starting batteries. If it cranks but does not start, check the fuel supply. If the problem persists, call your dealer or distributor.

⚠WARNING *Ignition of explosive battery gases can cause severe personal injury. Do not smoke or cause any spark or flame while servicing batteries.*

⚠WARNING *Ignition of fuel might cause severe personal injury or death by fire or explosion. Do not permit any flame, cigarette, spark, pilot light, arcing equipment, or other possible source of ignition near the fuel system.*

AFTER A POWER FAILURE, GENERATOR SET STARTS BUT DOES NOT ASSUME LOAD

1. Check the output voltage of the emergency power source by observing the voltmeter on the generator set or the optional voltmeter on the automatic transfer switch.
2. Open the cabinet door and check to see if the Motor Disconnect switch is in the Auto position.

⚠WARNING *AC power within the cabinet and the rear side of the cabinet door presents a shock hazard that can cause severe personal injury or death. Use extreme caution to avoid touching electrical contacts whenever the cabinet door is open.*

3. Check the Source 2 Available lamp on the Power Sentry to make sure that generator set power is being sensed.
4. Follow the Manual Operation procedures described in section 3. Call a service representative.

AFTER POWER RETURNS, TRANSFER SWITCH DOES NOT RETURN TO NORMAL POSITION

1. The retransfer time delay period may not have expired. Check the Retransfer Timing lamp on the Power Sentry
2. Open the cabinet door and check the Motor Disconnect switch position. For automatic operation, it should be in the Auto position.

⚠WARNING *AC power within the cabinet and the rear side of the cabinet door presents a shock hazard that can cause severe personal injury or death. Use extreme caution to avoid touching electrical contacts whenever the cabinet door is open.*

3. Manually initiate retransfer by turning the Test/Normal/Retransfer switch to Retransfer.
4. Stop the generator set with the Start/Stop switch. When the generator set stops, the transfer switch will transfer load to the Normal power source if power is acceptable. Call your dealer or distributor.
5. If the switch still does not retransfer, follow the Manual Operation procedures described in section 3. Call your dealer or distributor.

GENERATOR SET CONTINUES TO RUN AFTER RETRANSFER OF LOAD TO NORMAL POWER

The stop time delay function may not have expired. Check the Stop Timing lamp on the Power Sentry. Stop the generator set with its Start/Stop switch, and call your dealer or distributor.

BATTERY CHARGER FAILS TO CHARGE (IF EQUIPPED)

Check the battery charger fuse(s). Replace, if necessary, with fuses of the correct rating. Fuse ampere ratings are shown on the charger faceplate.

⚠WARNING *Ignition of explosive battery gases can cause severe personal injury. Do not smoke or cause any spark or flame while servicing batteries.*

If the fuse is OK, call your dealer or distributor

BATTERY LOSES WATER

The battery charger float voltage could be too high (if equipped with battery charger). Call your dealer or distributor.

BATTERY LOSES CHARGE

Battery charger float voltage could be too low (if equipped with battery charger). Call your dealer or distributor.



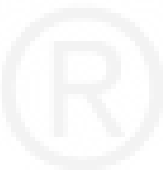

Cummins Power Generation

1400 73rd Ave. NE
Minneapolis, MN 55432 USA

Phone 1 763 574 5000

Toll-free 1 800 888 6626

Fax 1 763 574 5298

Email ask.powergen@cummins.com

www.cumminspower.com

Cummins®, the “C” logo, and “Our energy working for you.”
are trademarks of Cummins Inc.

©2013 Cummins Power Generation, Inc. All rights reserved.

