

Caution: This document contains mixed page sizes (8.5 x 11 or 11 x 17), which may affect printing. Please adjust your printer settings according to the size of each page you wish to print.

Installation Manual

Generator Sets

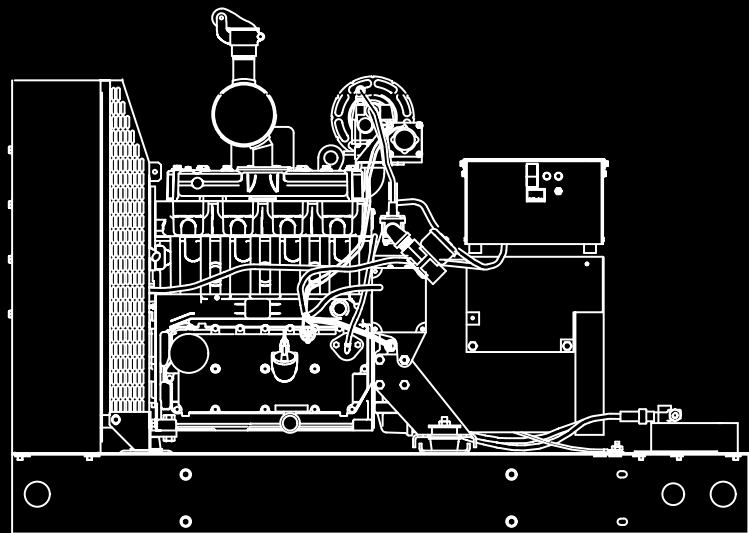

Models
GNAA, GNAB, GNAC



 **WARNING:** 
The engine exhaust from this product contains chemicals known to the State of California to cause cancer, birth defects or other reproductive harm.

Table of Contents

TITLE	PAGE
SAFETY PRECAUTIONS	ii
1. INTRODUCTION	1-1
About this Manual	1-1
Installation Overview	1-1
2. SPECIFICATIONS	2-1
3. MECHANICAL	3-1
Location	3-1
Access and Lighting	3-1
Mounting	3-1
Engine Exhaust	3-2
Cooling and Ventilation	3-3
Fuel	3-5
4. REMOTE CONTROL AND ANNUNCIATION	4-1
Wiring Methods	4-1
Manual Control	4-1
Remote/ATS Control	4-1
Detector Control	4-2
5. AC OUTPUT	5-1
Generator Connections	5-1
Load Balancing	5-1
Transfer Switch	5-3
Grounding	5-3
6. MISCELLANEOUS	6-1
Batteries	6-1
Coolant Heaters (Optional)	6-2
Generator and Control Heaters (Optional)	6-2
7. STARTUP AND INSTALLATION CHECKLIST	7-1
Startup	7-1
Installation Checklist	7-1
DETECTOR CONTROL CONNECTIONS	A-1
DETECTOR CONTROL—AUXILIARY RELAY BOARD CONNECTIONS	A-2

Safety Precautions

Thoroughly read the OPERATOR'S MANUAL before operating the generator set. Safe operation and top performance can be obtained only when equipment is operated and maintained properly.

The following symbols in this Manual alert you to potential hazards to the operator, service person and equipment.

⚠ DANGER *alerts you to an immediate hazard which will result in severe personal injury or death.*

⚠ WARNING *alerts you to a hazard or unsafe practice which can result in severe personal injury or death.*

⚠ CAUTION *alerts you to a hazard or unsafe practice which can result in personal injury or equipment damage.*

Electricity, fuel, exhaust, moving parts and batteries present hazards which can result in severe personal injury or death.

GENERAL PRECAUTIONS

- Keep ABC fire extinguishers handy.
- Make sure all fasteners are secure and torqued properly.
- Keep the generator set and its compartment clean. Excess oil and oily rags can catch fire. Dirt and gear stowed in the compartment can restrict cooling air.
- Let the engine cool down before removing the coolant pressure cap or opening the coolant drain. Hot coolant under pressure can spray out and cause severe burns.
- Before working on the generator set, disconnect the negative (-) battery cable at the battery to prevent starting.
- Use caution when making adjustments while the generator set is running—hot, moving or electrically live parts can cause severe personal injury or death.

- Used engine oil has been identified by some state and federal agencies as causing cancer or reproductive toxicity. Do not ingest, inhale, or contact used oil or its vapors.
- Do not work on the generator set when mentally or physically fatigued or after consuming alcohol or drugs.
- Carefully follow all applicable local, state and federal codes.

GENERATOR VOLTAGE IS DEADLY!

- Generator output connections must be made by a qualified electrician in accordance with applicable codes.
- The generator set must not be connected to the public utility or any other source of electrical power. Connection could lead to electrocution of utility workers, damage to equipment and fire. An approved switching device must be used to prevent interconnections.
- Use caution when working on live electrical equipment. Remove jewelry, make sure clothing and shoes are dry and stand on a dry wooden platform on the ground or floor.

FUEL IS FLAMMABLE AND EXPLOSIVE

- Keep flames, cigarettes, sparks, pilot lights, electrical arc-producing equipment and switches and all other sources of ignition well away from areas where fuel fumes are present and areas sharing ventilation.
- Fuel lines must be secured, free of leaks and separated or shielded from electrical wiring.
- Leaks can lead to explosive accumulations of gas. Natural gas rises when released and can accumulate under hoods and inside housings and buildings. LPG sinks when released and can accumulate inside housings, basements, sumps and other below-grade spaces. Prevent leaks and the accumulation of gas.
- Use approved non-conductive flexible fuel hose for fuel connections at the generator set.

ENGINE EXHAUST IS DEADLY!

- The exhaust system must be leak-free and convey all exhaust to the out-of-doors, away from buildings and building air vents, doors and windows. Look and listen for exhaust leaks daily and do not operate the generator set until all leaks have been fixed.
- Do not use engine exhaust or cooling air to heat a room or compartment.
- Make sure there is ample fresh air when operating the generator set.

BATTERY GAS IS EXPLOSIVE

- Wear safety glasses and do not smoke while servicing batteries.

- When disconnecting or reconnecting battery cables, always disconnect the negative (-) battery cable first and reconnect it last to reduce arcing.

MOVING PARTS CAN CAUSE SEVERE PERSONAL INJURY OR DEATH

- Do not wear loose clothing or jewelry near moving parts such as PTO shafts, fans, belts and pulleys.
- Keep hands away from moving parts.
- Keep guards in place over fans, belts, pulleys, etc.

KEEP THIS MANUAL NEAR THE GENERATOR SET FOR EASY REFERENCE

1. Introduction

ABOUT THIS MANUAL

This manual is a guide for the installation of the GN Series of generator sets. *Specifications* tabulates features of the generator set important for installation, operation and maintenance. Refer to the model-specific Outline Drawing, Specification Bulletin and Data Sheet for more information. *Mechanical, Remote Control and Annunciation, AC Output* and *Miscellaneous* cover different aspects of the installation. *Startup and Installation Review* covers the steps necessary to place the generator set in service. Fold-out wiring diagrams for remote connections and generator reconnections are included in the back.

INSTALLATION OVERVIEW

Proper *application* and *installation* are essential for *reliability* and *safety*.

Application: The proper application of a generator set to an emergency/standby power system requires the seasoned judgment of a professional engineer. This manual does not cover application. The system design/specifying engineer should refer to Application Manual T030—Liquid-Cooled Generator Sets—for recommendations concerning equipment selection and system design. The manual is in PDF format on the Power Systems Software Suite CD, which is available from your local Cummins/Onan Dealer. *The end user must determine wheth-*

er the generator set and emergency/standby system selected will be the proper one for its needs.

Installation: The proper installation of the generator set and all the other equipment included in the emergency/standby power system requires the skill of qualified electricians, mechanics, plumbers, sheetmetal workers and others. This manual covers as specifically as possible each aspect of the installation of the generator set and its connections. Call the Cummins dealer if questions remain.

Reliability and Safety: It is essential for reliability and safety that these instructions be followed closely and that the emergency/standby system, as a whole, complies with all applicable codes at the time it is placed in service.

⚠WARNING *The improper application or installation of a generator set can result in severe personal injury or death and property damage. The application must be made by a professional engineer and the installation by those qualified in the required electrical and mechanical trades. The emergency/standby power system must comply with all applicable codes.*

IMPORTANT NOTICE: Depending on the location of the generator set and its use, it may be necessary to obtain an air quality emissions permit before installation begins. Check with the local pollution control or air quality authority.

2. Specifications

	MODEL		
	GNAA	GNAB	GNAC
GENERATOR: Single-Bearing, 4-Pole Rotating Field, Brushless, Electronically Regulated. See generator set nameplate for rating.			
FULL LOAD FUEL CONSUMPTION:			
60 Hz LPG*	45 cfh	70 cfh	87 cfh
60 Hz NG*	95 cfh	144 cfh	206 cfh
50 Hz LPG*	33 cfh	50 cfh	67 cfh
50 Hz NG*	75 cfh	111 cfh	157 cfh
ENGINE: Electronically Governed, 4-Stroke Cycle Spark-Ignited, Water Cooled			
Number of Cylinders	2	3	4
Bore	86 mm (3.38 inch)	86 mm (3.38 inch)	86 mm (3.38 inch)
Stroke	80 mm (3.15 inch)	80 mm (3.15 inch)	80 mm (3.15 inch)
Displacement	0.93 liter (56.75 in ³)	1.40 liter (85.13 in ³)	1.86 liter (113.50 in ³)
Compression Ratio	9.5:1	9.5:1	9.5:1
Firing Order	1-2	1-2-3	1-3-4-2
Coolant Capacity	6.4 liter (6.8 quart)	7.1 liter (7.5 quart)	7.6 liter (8.0 quart)
Engine Oil Capacity**	3.4 liter (3.6 quart)	4.5 liter (4.7 quart)	5.6 liter (5.9 quart)
Ignition Timing—LPG*	10° BTDC		
Ignition Timing—NG*	20° BTDC		
Rotation	Clockwise (looking at radiator end)		
Valve Lash	Hydraulic tappets		
Spark Gap	0.021 inch (0.53 mm)		
Spark Plug Torque	28 lb-ft (40 N-m)		
Gas Supply Pressure—LPG* and NG*	5.5-20 inch (30-508 mm) WC (Water Column)		
Fuel Supply Connection	3/4 inch NPT female		
Maximum Exhaust Back Pressure	15 inch (381 mm) WC (Water Column)		
BATTERIES:***			
Nominal Battery Voltage	12 volts		
Minimum CCA (Cold Cranking Amps)	525 amps		
Charging Alternator Output	45 amps		
INSTALLATION SPECIFICATIONS:			
See the appropriate Specification Bulletin and Outline Drawing for minimum cooling air flow; fuel, exhaust and electrical connection points; overall dimensions; weight; etc.			
* LPG (liquified petroleum gas), NG (natural gas)			
** Includes Oil Filter			
*** A battery mounted in the built-in battery rack in the skid base must be of a type with barbed vent hose fittings for its cells. The vent lines must be routed away from the generator end bell (air inlet) to prevent battery gasses from entering the generator and causing corrosion.			

3. Mechanical

LOCATION

Generator set location is a matter for system design and application (see *Introduction*). Factors such as engine exhaust, noise, ventilation, ambient temperature, security, location of the distribution switchboard, foundation or supporting structure and access for maintenance and service all affect the decision about where to locate the generator set.

Weather/vandal-protective housings are available for outdoor installations.

ACCESS AND LIGHTING

Generally, at least 1 meter (3 feet) of clearance should be provided on all sides of the generator set for maintenance and service access. A raised foundation or slab of 150 mm (6 inches) or more above floor level will make servicing easier.

Lighting should be adequate for operation, maintenance and service operations and should be connected on the load side of the transfer switch so that it is available at all times.

MOUNTING

The foundation, floor or roof must be level and be able to support the weight of the generator set, resist the dynamic loads and not transmit objectionable noise and vibration. The generator set has a skid base or two mounting brackets with rubber vibration isolators. Generally, additional vibration isolation is not required. See the appropriate outline drawing for the anchor bolt hole locations in the skid base or mounting brackets. Figure 3-1 illustrates a typical anchor bolt for concrete foundations.

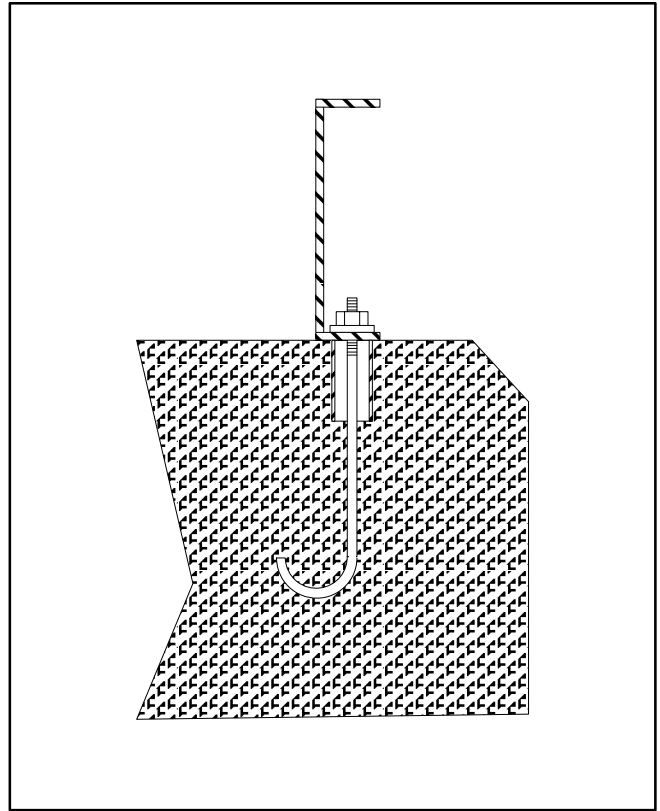

FIGURE 3-1. TYPICAL CONCRETE ANCHOR BOLT

ENGINE EXHAUST

The engine exhaust system must be gas-tight. It must convey engine exhaust safely to the out-of-doors and disperse the fumes, soot and noise away from people and buildings.

⚠WARNING ***EXHAUST GAS IS DEADLY! The exhaust system must be gas-tight and terminate away from buildings and building vents, windows and doors and areas where exhaust can accumulate.***

Schedule 40 black iron pipe is recommended for exhaust piping. Figure 3-2 shows the exhaust flange drawing for connection at the engine. Engine-mounted mufflers are available as an option and have 1-1/4 inch NPT outlet connection.

Flexible, corrugated stainless steel exhaust tubing at least 457 mm (18 inches) long must be connected between the engine or engine mounted muffler and exhaust piping. It must not be used to form bends or to compensate for misaligned piping.

Mufflers (other than engine-mounted) and piping must be supported on non-combustible hangers so that the weight does not cause damage to the engine manifold or turbocharger.

Exhaust piping must be shielded or insulated by approved methods or be routed not closer than 229 mm (9 inches) to combustible material. Use an approved thimble (Figure 3-3) where exhaust piping passes through a combustible wall, partition, ceiling or roof.

⚠WARNING ***Exhaust piping can ignite combustible material. Use approved methods for routing, insulating and shielding exhaust pipe.***

A rain cap must be provided if the exhaust outlet points up.

Horizontal runs of piping should slope downwards away from the engine to a condensate trap or to the outlet. A condensate drain tap and plug should be provided where piping turns to rise vertically.

Exhaust backpressure under full load must not exceed that specified on the Specification Sheet. Pipe bends should be sweeping and pipe diameter should be at least the same as, but never smaller than, the outlet at the engine or mounted muffler. See Application Manual T-030 for a method for calculating and testing exhaust backpressure.

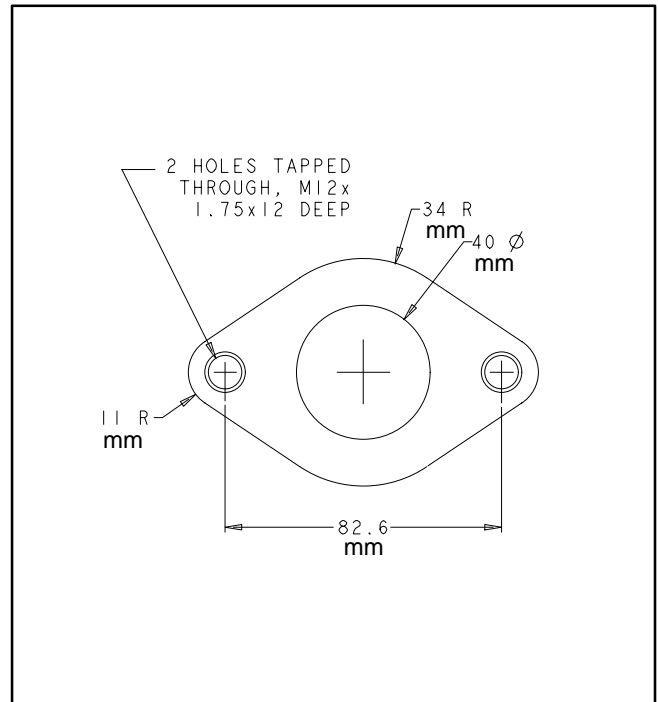

FIGURE 3-2 EXHAUST FLANGE

COOLING AND VENTILATION

Generator sets dissipate heat and fumes that must be removed by proper cooling and ventilation.

Generator sets in factory-mounted housings for outdoor installation are designed for proper cooling and ventilation.

Indoor installations require careful design with respect to cooling and ventilation. In an indoor installation radiator cooling air must be discharged to the out-of-doors. Figure 3-3 illustrates a typical installation.

Radiator cooling air must not be used for heating a room or compartment.

▲WARNING *Radiator cooling air may carry deadly carbon monoxide gas which can cause asphyxiation and death. Radiator cooling air must be discharged to the out-of-doors. Do not use it for heating a room or compartment.*

Flexible duct connectors (canvas) should be used at the generator set to take up movement and vibration.

See the Specification Sheet for air handling parameters such as air flow, minimum air inlet and outlet opening sizes and static pressure drop. See Ap-

plication Manual T-030 for a method for calculating required ventilating air flow.

Louvers and screens over air inlet and outlet openings restrict air flow and vary widely in performance. A louver assembly with narrow vanes, for example, tends to be more restrictive than one with wide vanes. The effective open area specified by the louver or screen manufacturer should be used.

In colder climates it may be necessary to use dampers to close off the inlet and outlet air openings to keep the generator room warm when the set is not running. These must be controlled by the generator set such that they are open when the set is running. The auxiliary relay board (ARB) that is optional with the Detector control can provide such operation.

Also, in colder climates, a thermostatically controlled recirculating damper in the radiator discharge duct may be used to reduce the volume of cold air drawn into the generator room.

If possible, the room air inlet opening should be located across the room and at a lower elevation than the outlet so that the cooling and ventilating air will sweep over the equipment and move through by natural convection.

Ventilating air inlet and discharge openings should be located or shielded to minimize fan noise and the effects of wind on airflow.

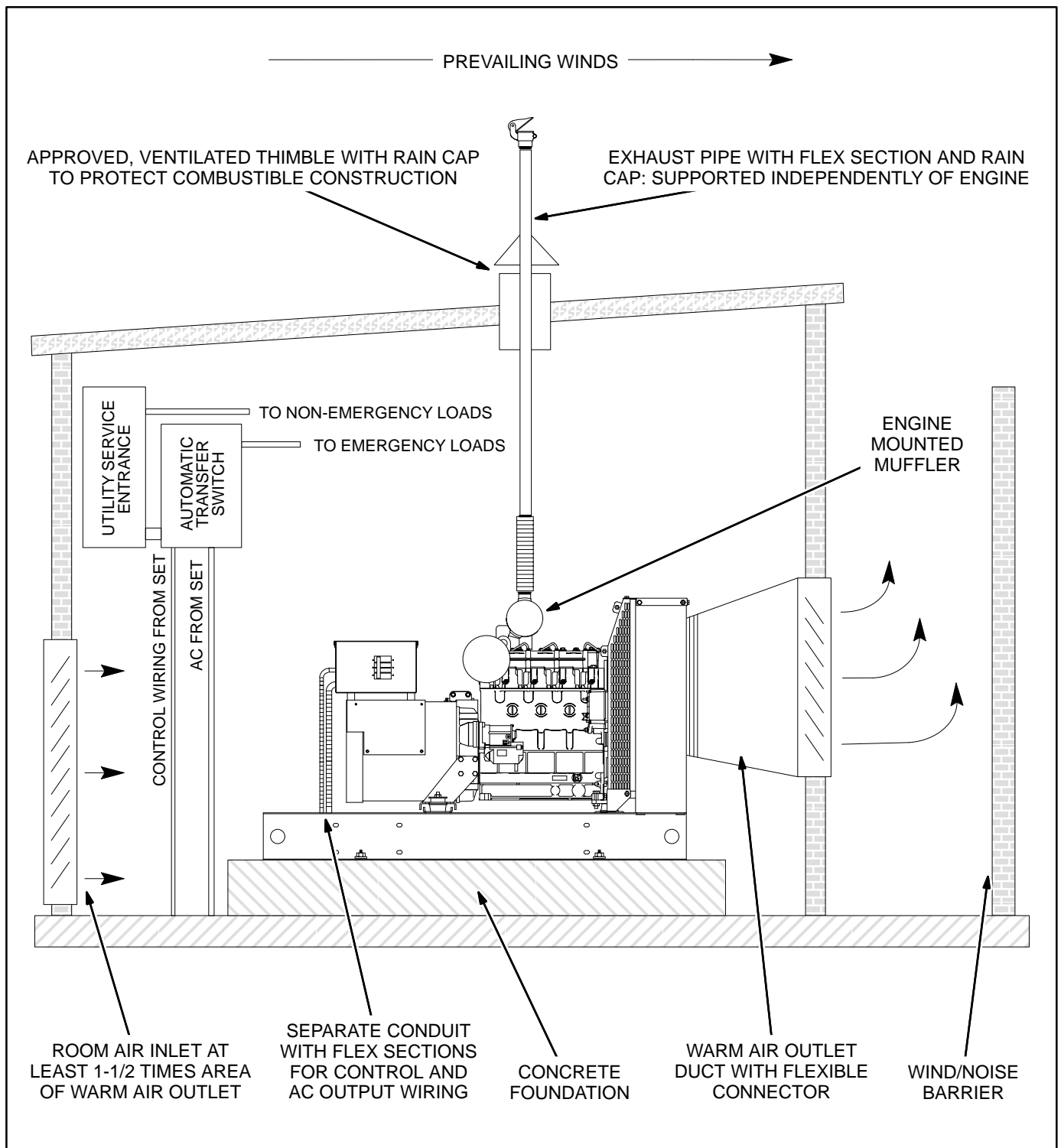

FIGURE 3-3. TYPICAL INDOOR EMERGENCY STANDBY INSTALLATION

FUEL

See *Operation* in the Operator's Manual for fuel recommendations. Gaseous fuel supply system design, materials, components, fabrication, assembly, installation, testing, inspection, operation and maintenance must comply with the applicable codes. See NFPA Standards No. 37, 54 and 58.

⚠WARNING *Gaseous fuels are flammable and explosive and can cause severe personal injury or death. Do not smoke if you smell gas or are near fuel tanks or fuel-burning equipment or are in an area sharing ventilation with such equipment. Keep flames, sparks, pilot lights, electrical switches, arc-producing equipment and all other sources of ignition well away. Keep a type ABC fire extinguisher handy.*

NFPA Standard No. 58 requires all persons handling and operating LPG to be trained in proper handling and operating procedures.

The gas supply connection at the genset is a 3/4 inch NPT fitting. Approved flexible fuel hose must be used for fuel supply connections at the engine to take up generator set movement and vibration.

Install a manual gas shutoff valve within sight of the genset. Cap the fuel line stub-up at the genset until the genset is connected to prevent dirt from entering and gas discharging if the gas supply shutoff valve is opened inadvertently.

Install a dry-type fuel filter ahead of the service pressure regulator to protect the sensitive pressure regulating components and orifices downstream from rust, scale and other solid substances carried along in the gas stream.

⚠WARNING *Gaseous fuel leaks into an inadequately ventilated space can lead to explosive accumulations of gas. Natural gas rises when released into the air and can accumulate under overhanging hoods and inside housings and buildings. LPG sinks when released into the air and can accumulate inside housings, basements, sumps and other below-grade spaces. Precautions must be taken to prevent gas leaks and the accumulation of gaseous fuel in the event of a leak.*

An LPG tank must hold enough fuel to run the generator set for the prescribed number of hours before refueling (NFPA No. 110 Class designation). Tank sizing must take into account the coldest ambient temperatures expected. See Application Manual T-030.

For satisfactory performance the gas must be supplied at the specified pressure. See *Specifications*.

⚠WARNING *High gas supply pressure can cause gas leaks which can lead to fire and severe personal injury or death. Gas supply pressure must be adjusted to Specifications by qualified personnel.*

4. Remote Control and Annunciation

WIRING METHODS

If the distance between the generator set and the remote station is less than 300 m (1000 feet), use 18 gauge stranded copper wire. If the distance is 300 to 600 m (1000 to 2000 feet), use 16 gauge stranded copper wire.

Always run control and annunciation circuit wiring in separate conduit from AC power wiring to avoid inducing false signals in the control circuits.

⚠WARNING **HAZARDOUS VOLTAGE** *Touching uninsulated live parts inside the control or output box can result in severe personal injury or death. For your protection, stand on a dry wooden platform or rubber insulating mat, make sure your clothing and shoes are dry, remove jewelry from your hands and use tools with insulated handles.*

⚠WARNING *Accidental starting can cause severe personal injury or death. To prevent accidental starting, push the control panel switch to OFF and disconnect the negative (-) battery cable from the battery before working on the generator set.*

⚠WARNING *Arcing can ignite battery gases and cause severe personal injury and can cause voltage spikes that can damage generator set control circuits. To reduce arcing:*

Always disconnect a battery charger from its AC source before disconnecting the battery cables.

Always disconnect the negative (-) cable first and reconnect it last. (This prevents arcing if the tool on the positive terminal touches grounded metal.)

MANUAL CONTROL

Manual Control generator sets have no provision for remote control.

REMOTE/ATS CONTROL

Remote/ATS Control generator sets have provision for 2-wire remote start/stop control. Connections are made at terminals 2 and 3 on the control terminal block inside the control box. See Figure 4-1.

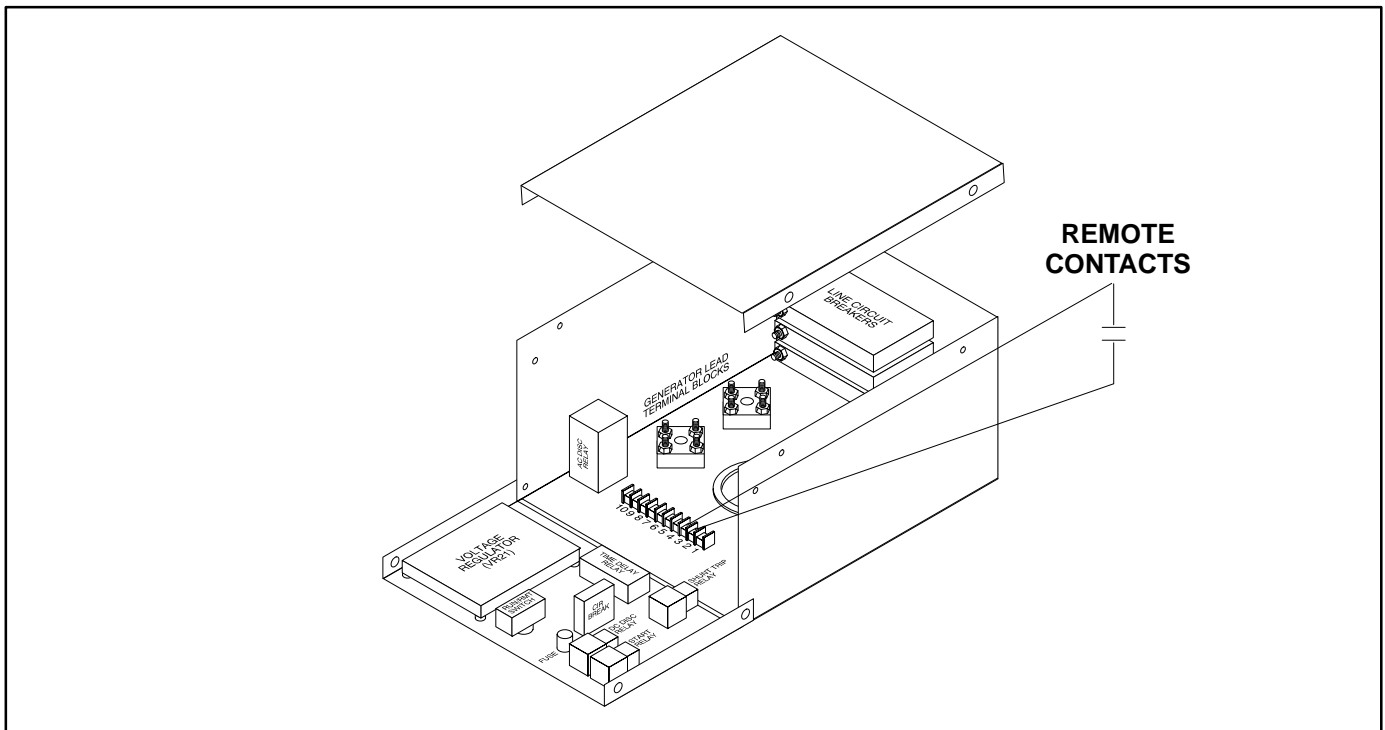

FIGURE 4-1. REMOTE START/STOP TERMINALS—REMOTE/ATS CONTROL

Dry Contact Module (Optional)

The dry contact module provides for the connection of remote monitoring devices. Make the connections to the 1/4 inch (5.35 mm) quick-connect terminals on relays **K8** and **K9** of the module (Figure 4-2). The pilot duty ratings of the monitoring devices must not exceed 15 amperes.

The following faults will activate relays **K8** or **K9** as follows:

RELAY K8	RELAY K9
Over Crank Low Oil Pressure High Engine Temperature Low Coolant Level	Low Fuel Pressure

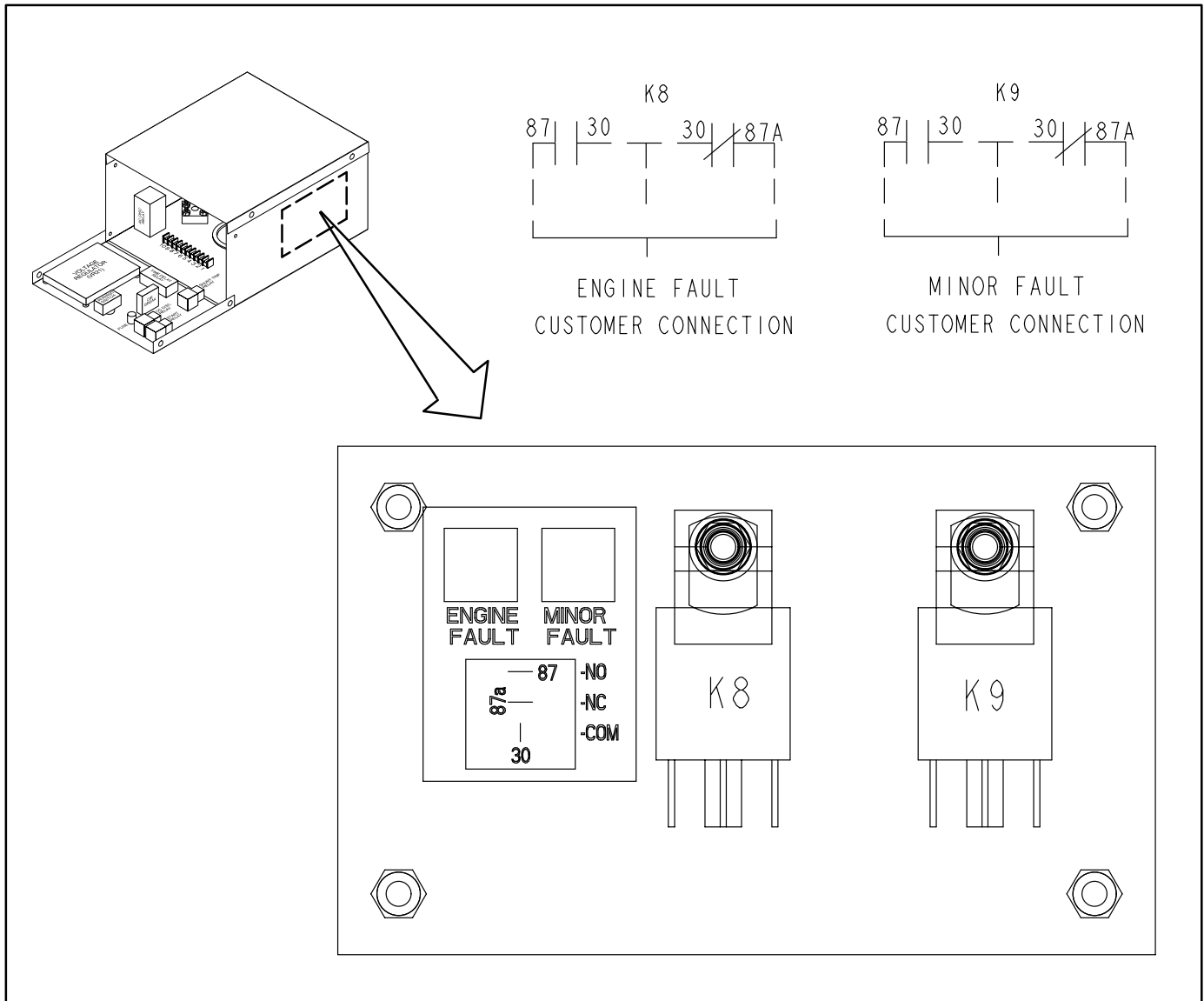

FIGURE 4-2. DRY CONTACT MODULE

DETECTOR CONTROL

The generator set control box has connection points for remote control and annunciation. These connection points are on the engine control monitor (ECM), Figure 4-3; optional auxiliary relay board (ARB), Figure 4-4; and start-stop time delay module, Figure 4-5.

Engine Control Monitor (ECM)

The engine control monitor (ECM) is a printed circuit board assembly mounted on the side wall of the control box (Figure 4-3). See Page NO TAG for the connection diagram.

Remote Start/Stop: Connections for remote start/stop are made at **A11-TB1-7 (B+)** on the ECM and at **A15-TB1-5** on start-stop time delay module A15 (Page 4-7). See Page 4-5 for connections when the optional auxiliary relay board is provided.

Remote Annunciation: Connections for remote annunciation are made at terminal blocks **TB1** and **TB2**. See Page 4-5 for connections when the optional auxiliary relay board is provided.

Function Selection Jumpers: The ECM board has six selection jumpers that can be repositioned to provide the following timed or non-timed warnings or timed or non-timed shutdowns with warnings:

- W1** Jumper Position (jumper **W8** must be in the **B** position):
 - A** Non-timed warning under **FLT 2** conditions.
 - B** Non-timed shutdown under **FLT 2** conditions.
 - C** Timed warning under **FLT 2** conditions.
 - D** Timed shutdown under **FLT 2** conditions.
- W2** Jumper Position (jumper **W9** must be in the **B** position):
 - A** Non-timed warning under **FLT 1** conditions.
 - B** Non-timed shutdown under **FLT 1** conditions.
 - C** Timed warning under **FLT 1** conditions.
 - D** Timed shutdown under **FLT 1** conditions.
- W6** Jumper Position:
 - A** Warning under **Pre-High Engine Temperature** conditions.
 - B** Shutdown under **Pre-High Engine Temperature** conditions.
- W7** Jumper Position:
 - A** Warning under **Pre-Low Oil Pressure** conditions.
 - B** Shutdown under **Pre-Low Oil Pressure** conditions.
- W8** Jumper Position:
 - A** Warning while running or during standby under **FLT 2** conditions.
 - B** Allows selection of functions with **W1** jumper.
- W9** Jumper Position:
 - A** Warning while running or during standby under **FLT 1** conditions.
 - B** Allows selection of functions with **W2** jumper.

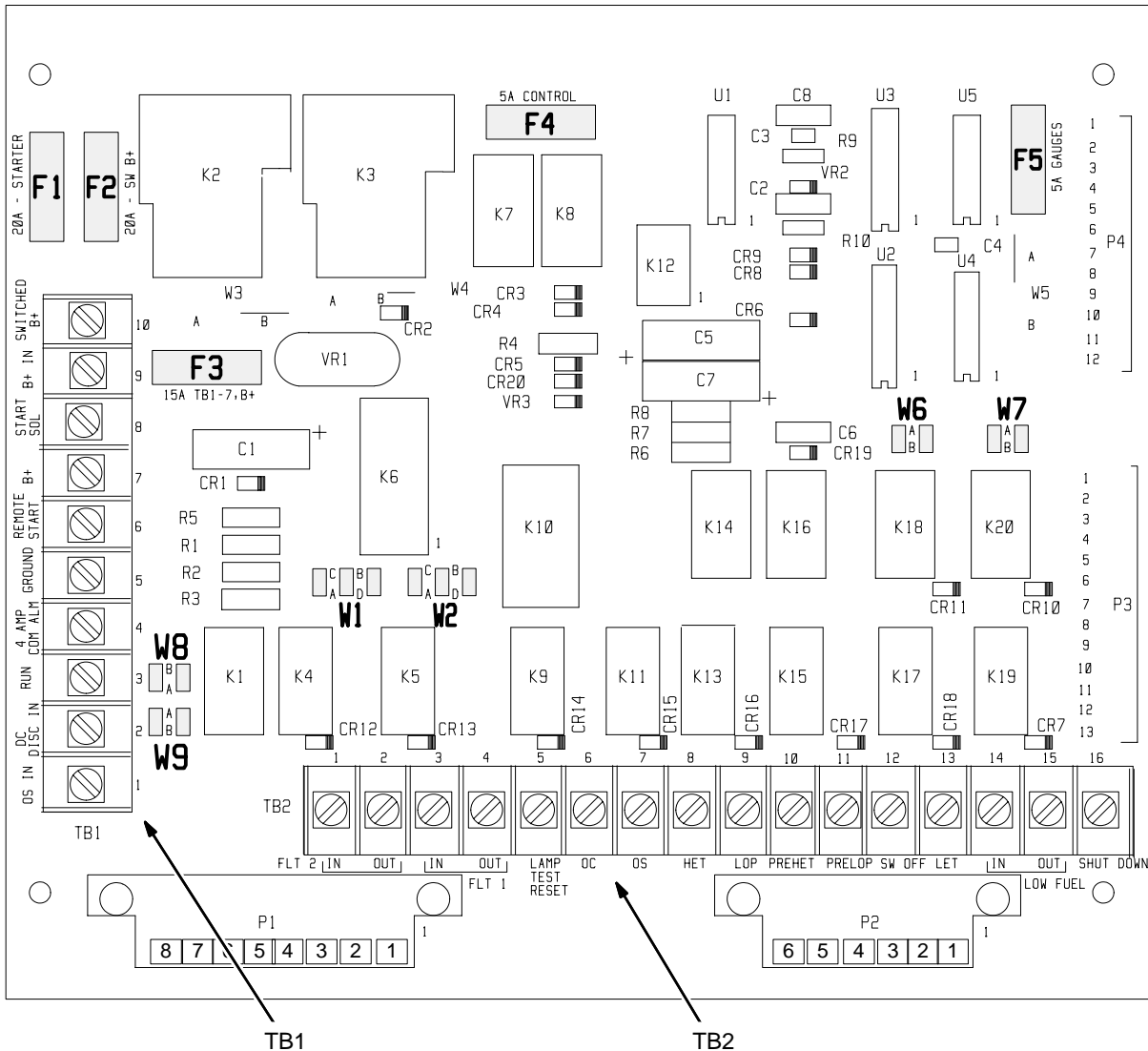
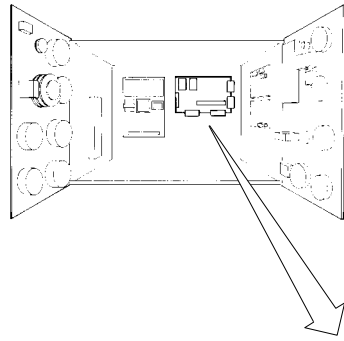

FIGURE 4-3. ENGINE CONTROL MONITOR (ECM)

Auxiliary Relay Board (Optional)

The auxiliary relay board (ARB) is a printed circuit board assembly mounted on the back wall of the control box (Figure 4-4). See Page NO TAG for the connection diagram.

Terminal Blocks:

- **TB1** - ARB TB1 and engine monitor TB1 are identically numbered and provide the same remote control connection points. Note that additional terminals are provided for terminals 5, 7, and 10 of ARB TB1.
- **TB2 through TB5** - Connection points for relays K1 through K3. TB2 provides the N/O and N/C connections (three form 'C' contacts for each relay). TB3 through TB5 provide the common connection points (TB3 for K1, TB4 for K2 and TB5 for K3).
- **TB6 and TB7** - Connection points for fault relays K4 through K15. Three terminals are provided for each relay, which are labeled COM, N/C, N/O.

Plug-In Relays (K1, K2, K3): The ARB can be equipped with one to three 3-pole, double-throw relays. These relays (K1, K2, K3) are field changeable plug-in relays for easy field addition and replacement.

Each relay can be operated as a RUN, COMMON ALARM, or ISOLATED COIL with the changing of a jumper.

The relay contact ratings are:

- 10 amps at 28 VDC or 120 VAC, 80% PF
- 6 amps at 240 VAC, 80% PF
- 3 amps at 480 VAC, 80% PF

Jumper Positions for Plug-In Relays: Jumpers W1, W2 and W3 perform the same functions for their respective relays, W1 for relay K1, W2 for relay K2, and W3 for relay K3. They can be located in any of 3 positions (A, B, C) independently of each other.

- **Jumper Position A (Run)** - The relay operates as a Run relay, energizing when SW B+ is applied from the engine monitor.
- **Jumper Position B (Common Alarm)** - The relay operates as a Common Alarm relay. The relay energizes any time there is an engine shutdown.
- **Jumper Position C (Isolated)** - The relay operates as an Isolated relay. The relay coil is energized by a customer applied B+ signal through the terminal block; TB3-1 for relay K1, TB4-1 for relay K2, and TB5-1 for relay K3.

Jumpers W11, W12, and W13 perform the same functions for their respective relays; W11 for relay K1, W12 for relay K2, and W13 for relay K3. They can be located in two different positions (A, B) independently of one another.

- **Jumper Position A** - The relay operates isolated from the board. The customer provides the circuit completion through terminal block; TB3 for relay K1, TB4-5 for relay K2, and TB5-5 for relay K3. The customer can operate the relay with switched ground logic or use this relay in the middle of more complex logic circuits if needed.
- **Jumper Position B** - The relays operate with the coils connected to ground through the board connections. The coil will require a B+ signal to energize with the jumper in this position.

Fault Relays (K4 through K15): These relay modules are used to operate a remote alarm annunciator that has an independent power source. This allows the use of either AC or DC for alarm drives. The relays are energized through the latching relays on the engine monitor and provided N/O and N/C contacts for each external alarm connection.

The 12 relays with form 'C' contacts are rated:

- 10 Amp, 120 VAC
- 10 Amp, 30 VDC

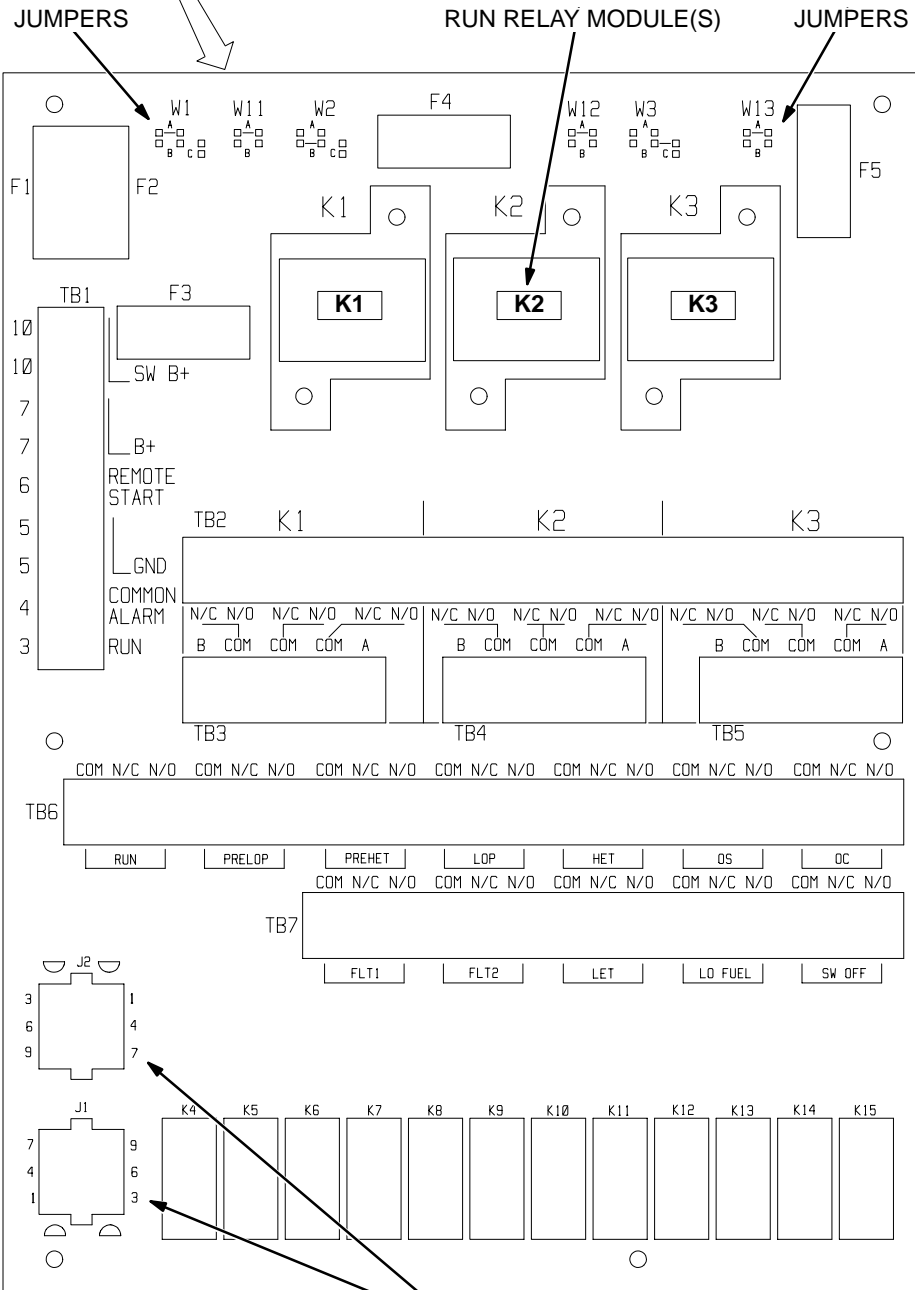
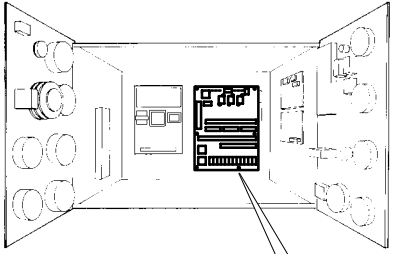

J1, J2 WIRE HARNESS PLUG CONNECTIONS FROM A11

FIGURE 4-4. AUXILIARY RELAY BOARD (ARB)

Start-Stop Time Delay Module

Start Delay: Start delay is adjustable from 5 to 15 seconds. Turn the potentiometer clockwise to increase delay and counterclockwise to decrease delay. See Figure 4-5.

Stop Delay: Stop delay is adjustable from 30 seconds to 30 minutes. Turn the potentiometer clock-

wise to increase delay and counterclockwise to decrease delay.

Remote Start/Stop: Connections for remote start/stop are made at **A11-TB1-7 (B+)** on the ECM and at **A15-TB1-5** on the time delay module (A15). Connections are made instead on the auxiliary relay board (Figure 4-4) when it is provide.

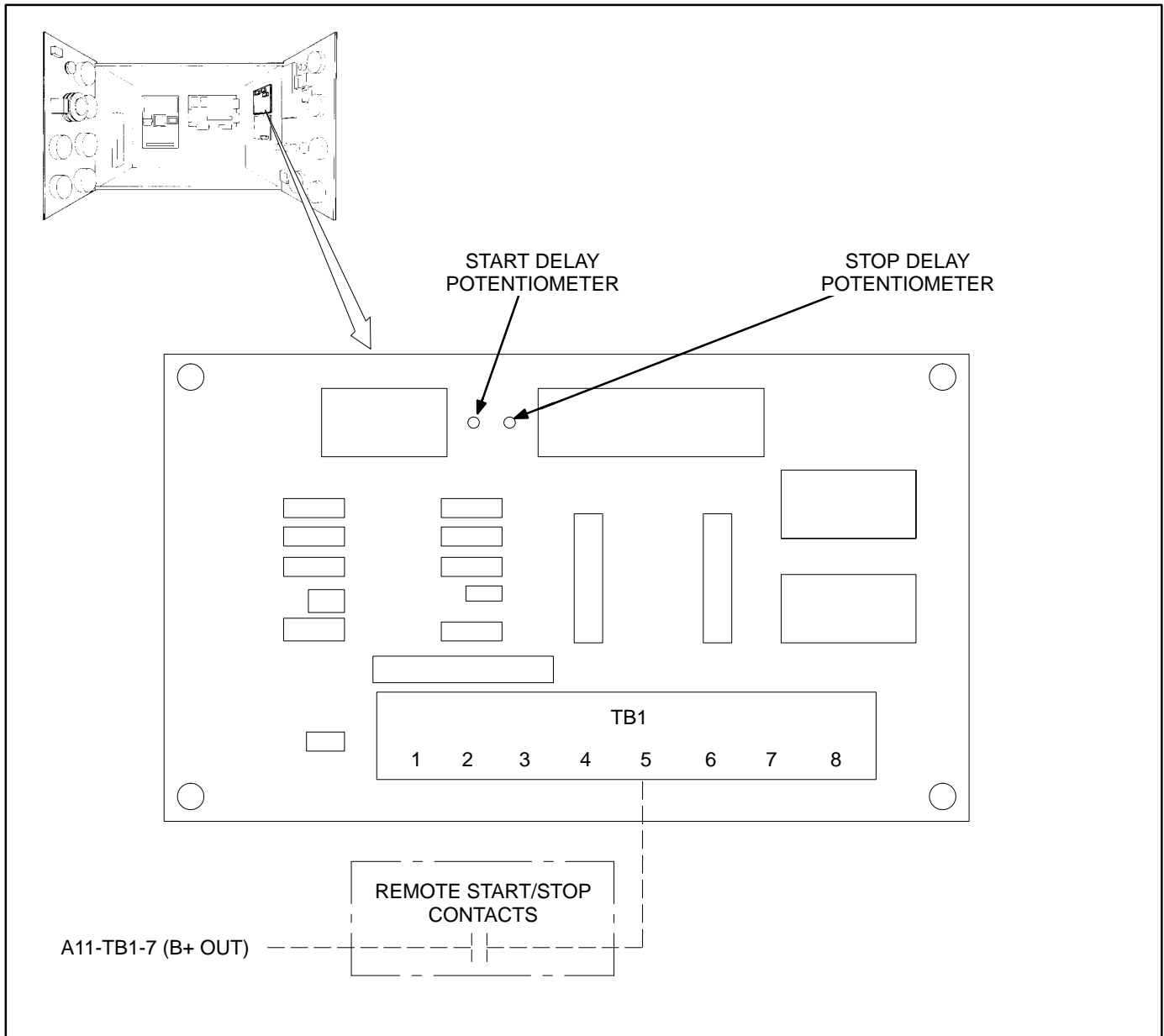

FIGURE 4-5. START-STOP TIME DELAY MODULE ADJUSTMENTS AND CONNECTIONS

5. AC Output

GENERATOR CONNECTIONS

⚠WARNING *Improper wiring can cause fire or electrocution resulting in severe personal injury or death and property damage.*

⚠WARNING **HAZARDOUS VOLTAGE** *Touching uninsulated live parts inside the control or output box can result in severe personal injury or death. For your protection, stand on a dry wooden platform or rubber insulating mat, make sure your clothing and shoes are dry, remove jewelry from your hands and use tools with insulated handles.*

⚠WARNING *Accidental starting can cause severe personal injury or death. To prevent accidental starting, push the control panel switch to OFF and disconnect the negative (-) battery cable from the battery before working on the generator set.*

⚠WARNING *Arcing can ignite battery gases and cause severe personal injury and can cause voltage spikes that can damage generator set control circuits. To reduce arcing:*

Always disconnect a battery charger from its AC source before disconnecting the battery cables.

Always disconnect the negative (-) cable first and reconnect it last. (This prevents arcing if the tool on the positive terminal touches grounded metal.)

Local regulations usually require that wiring connections be made by a licensed electrician and that

the installation be inspected and approved before operation. All wiring methods, connections, wire ampacities, equipment grounding, materials, etc. must comply with the applicable codes.

Use flexible conduit and stranded conductors to make connections at the generator set to take up movement and vibration. Note the recommended electrical stub up area on the generator set outline drawing.

Generator connections are made in the control box on top of the generator (Figure 5-1). Eight terminals on two terminal blocks are provided for connections. If mounted circuit breakers are provided, connections can be made directly to the circuit breakers.

Twelve-lead generators are reconnectable. See the appropriate reconnection diagram on the cover of the output box (inside).

Note 1: *If the generator set is equipped with meters, the scale indicator lamp on the control panel will indicate whether the upper or low meter scale should be read, if generator reconnections have been made properly.*

Note 2: *If the generator is equipped with line circuit breakers and generator reconnections are made, the line circuit breakers will have to be replaced with circuit breakers having appropriate ampere ratings.*

LOAD BALANCING

Check load balance between phases (L1, L2 and L3) and redistribute the loads if necessary so that current does not exceed nameplate rating for any phase. It is recommend that loads be balanced within 10 percent across the phases.

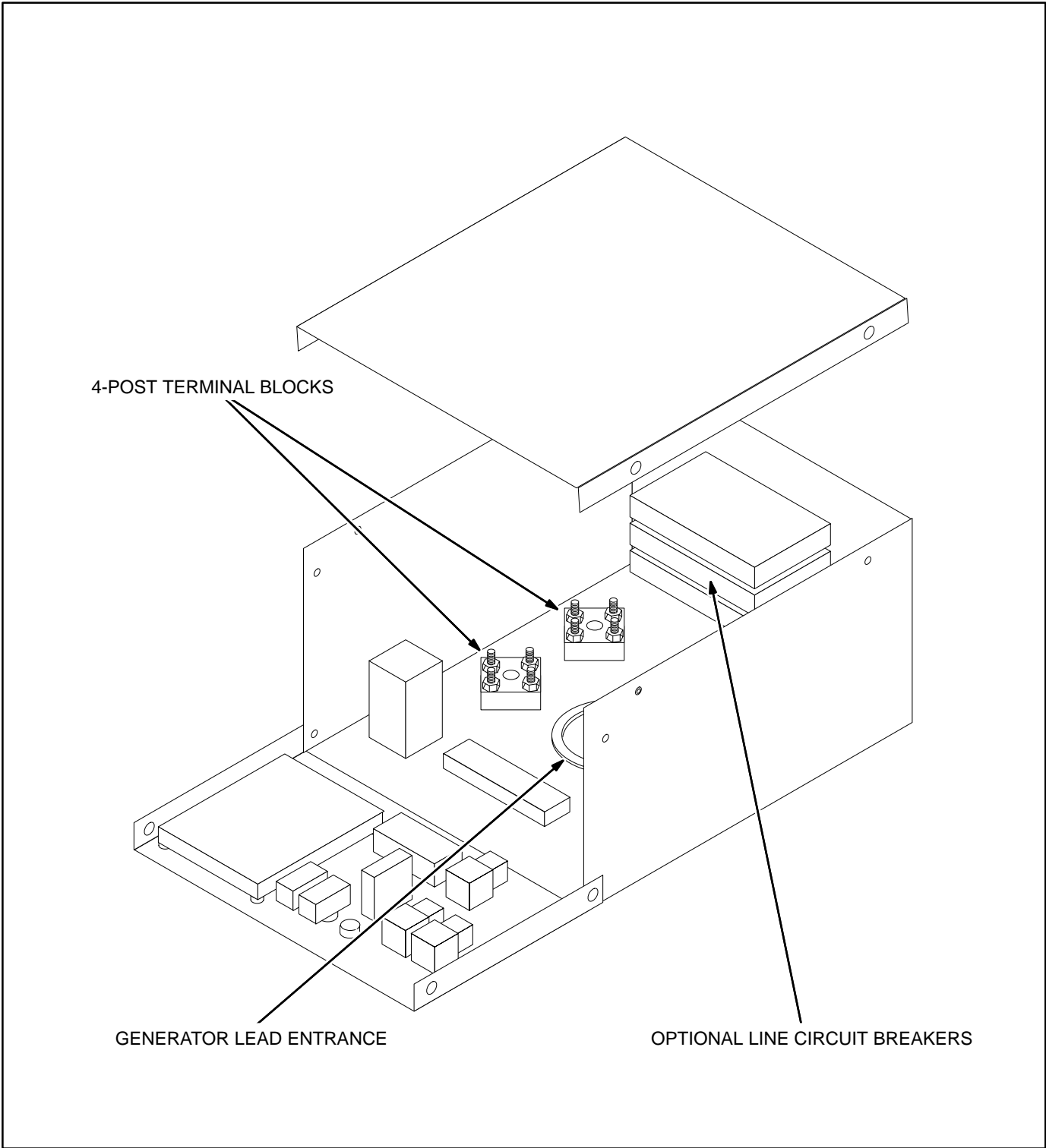

FIGURE 5-1. TYPICAL AC OUTPUT BOX

TRANSFER SWITCH

If the installation is for standby service, a transfer switch must be used for switching the load from the normal power source to the generator set (see Figure 5-2). Either manual or automatic transfer switches may be used. Follow the installation instructions provided with the transfer switch when connecting wiring.

⚠️WARNING *Backfeed to a utility system can cause electrocution and property damage. Do not connect to any building electrical system except through an approved device.*

GROUNDING

Refer to Article 250 of the National Electrical Code

for typical requirements for bonding and grounding permanently installed AC generators. Figure 5-2 illustrates typical system grounding for 3-pole and 4-pole automatic transfer switches (ATS). In a 3-pole ATS the generator neutral is connected to the ATS and is NOT bonded to ground at the generator. In a 4-pole ATS system, a grounding electrode conductor and a bonding jumper are used to connect the generator neutral to ground. In some installations a CT may be required for ground fault monitoring (Figure 5-2).

⚠️WARNING *Contact with improperly grounded electrical equipment can result in severe personal injury or death. All metal parts that could become energized under abnormal conditions must be properly grounded.*

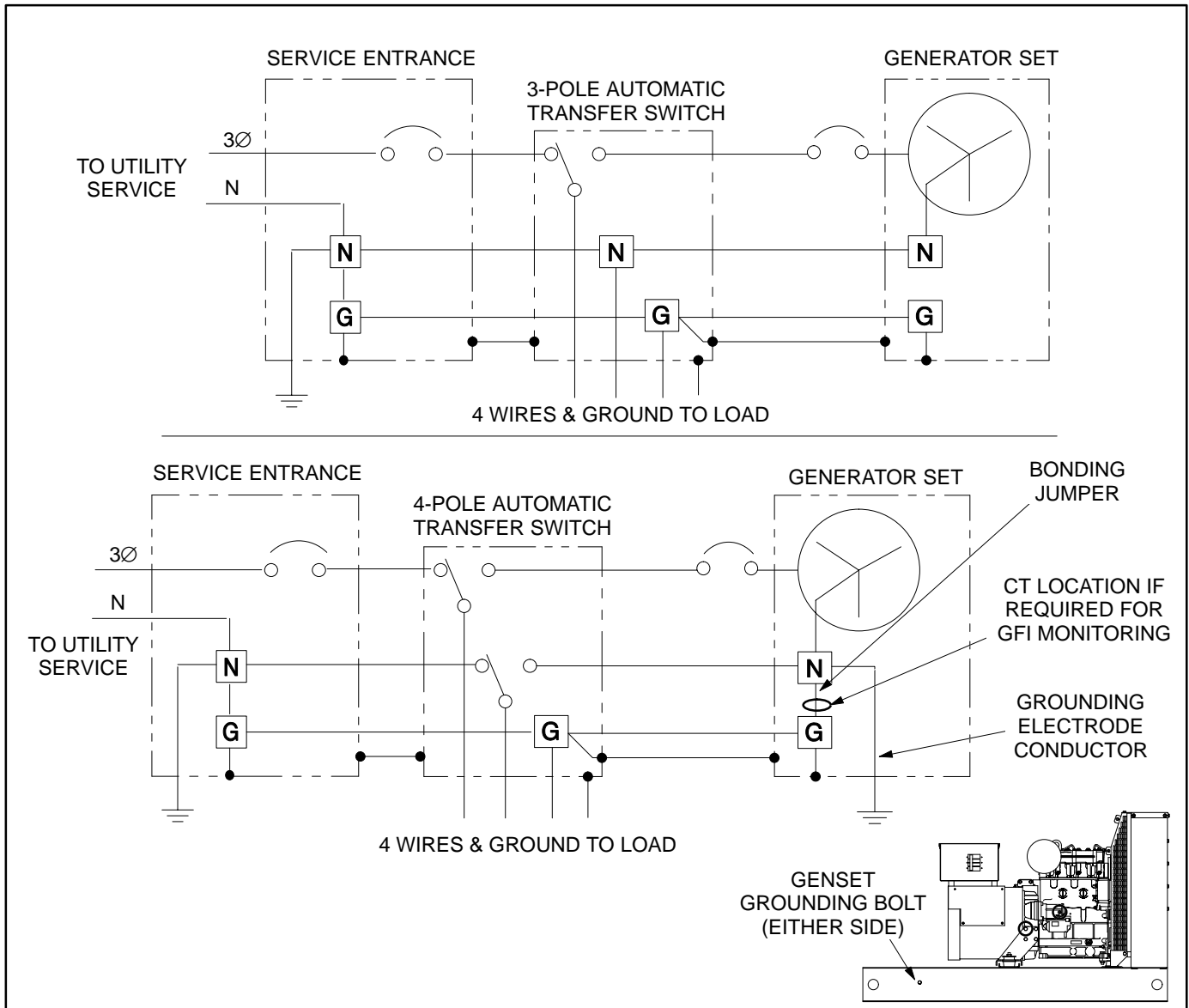

FIGURE 5-2. TYPICAL TRANSFER SWITCH AND SYSTEM GROUNDING CONNECTIONS

6. Miscellaneous

BATTERIES

The generator set has a 12 VDC, negative-ground control and starting system. See Figure 6-1 for battery cable connections and *Specifications* for minimum battery requirements.

The engine is equipped with a 45 amp battery charging alternator to supply the control loads and restore cranking current. Emergency standby applications will require a battery charger powered by the normal AC power supply. Check the local codes for emergency standby requirements.

Locate the battery as close to the generator set as practicable to minimize starting circuit resistance and allow easy access for maintenance and replacement. A generator set with a skid-base has a built-in battery rack. See Application Manual T-030 for battery cable size calculations.

⚠ WARNING *Accidental starting can cause severe personal injury or death. Push the control panel switch to OFF before connecting the battery cables.*

⚠ WARNING *Arcing can ignite battery gases and cause severe personal injury and can cause voltage spikes that can damage generator set control circuits. To reduce arcing:*

Always disconnect a battery charger from its AC source before disconnecting the battery cables.

Always disconnect the negative (-) cable first and reconnect it last. (This prevents arcing if the tool on the positive terminal touches grounded metal.)

⚠ CAUTION *A battery mounted in the skid rack must be of a type with barbed vent hose fittings for its cells. The vent lines must be routed away from the generator end bell (air inlet) to prevent battery gases from entering the generator and causing corrosion.*

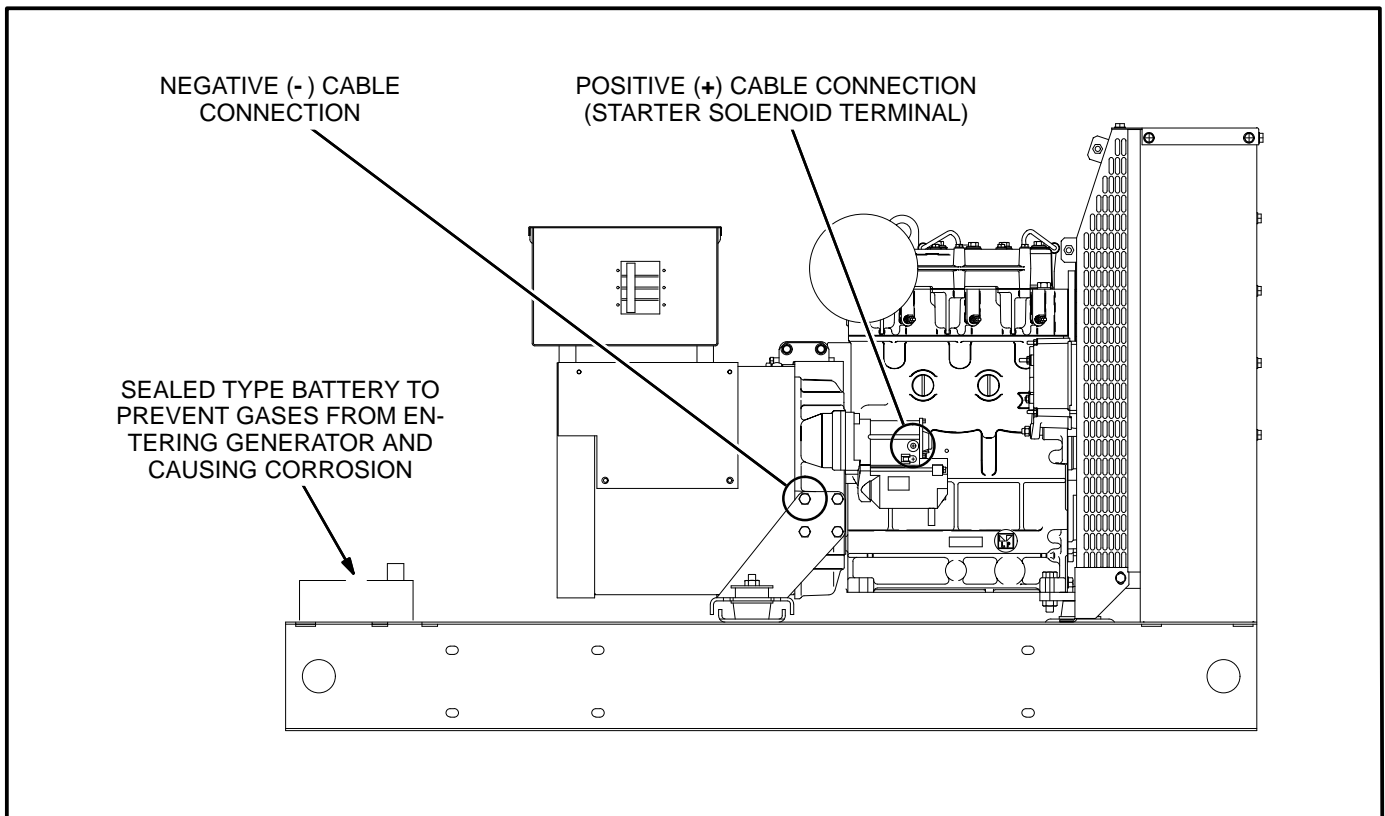

FIGURE 6-1. BATTERY CONNECTIONS

COOLANT HEATER (OPTIONAL)

An engine block heater is available for faster starting in cold weather. The heater is equipped with a power cord that terminates with a 120V or 240V NEMA plug. Connect the heater to a source of power that will be on during the time the generator set is not running. Be sure the voltage rating is correct for the heater element rating.

Generator sets in emergency standby applications are required to start and pick up all emergency loads within 10 seconds of power failure. An engine coolant heater is usually required to meet such a requirement. Generator sets with Detector control have a low engine temperature alarm as required

by NFPA 110 for Level 1 systems. Check the local codes for emergency/standby requirements.

GENERATOR AND CONTROL HEATERS (OPTIONAL)

Heaters are available to drive off moisture that could condense on generator windings and control wiring and connections. They are equipped with power cords that terminate with 120V or 240V NEMA plugs. Connect them to a source of power that will be on during the time the generator set is not running. Be sure the voltage rating is correct for the heater element rating.

7. Startup and Installation Checklist

STARTUP

Before starting the generator set, review the INSTALLATION CHECKLIST for those items that do not require the generator set to be actually running. Make necessary repairs, reconnections and modifications. Then start and operate the generator set in accordance with the Operator's Manual, observing all of its instructions and safety precautions. Continue working through the INSTALLATION CHECKLIST with the genset running, making necessary repairs, reconnections and modifications. Check (✓) each item that can be answered positively. Do not place the generator set in service until all applicable items can be checked off.

INSTALLATION CHECKLIST

- The engine has the proper levels of oil and coolant. (The generator set is shipped from the factory with the proper levels of oil and coolant, which should be checked, nonetheless.)
- A proper battery has been installed, serviced and charged.

⚠WARNING *Accidental starting can cause severe personal injury or death. Push the control panel switch to OFF before connecting the battery cables.*

- The generator set is securely and adequately mounted. The level of vibration and noise transmitted to the building or structure is acceptable.
- There is at least 1 meter (3 feet) of clearance on all sides of the generator set and adequate lighting for maintenance and service.
- The exhaust system is leak-free and conveys all engine exhaust to the out-of-doors, away from buildings and building air intakes, windows and doors and areas where exhaust can accumulate.
- Approved methods and materials are used to protect combustible construction and operators from hot mufflers and piping.
- Exhaust back pressure and noise are acceptable.
- All engine cooling and ventilating air is ducted or discharged directly to the out-of-doors and is not used for heating any enclosed space.

- Cooling and ventilating air ducts and openings are properly sized and are protected against the effects of wind. Fan noise is acceptable.
- Approved gas supply hose is used for connections at the engine.
- The gas supply system is leak-free.
- Gas supply pressure is adequate and has been adjusted properly.
- The LPG supply tank has been sized to provide the required vaporization rate on the coldest days expected.
- The entire gas supply system complies with and has been tested in accordance with applicable codes.
- An approved transfer switch prevents interconnections with utility power.
- Wiring methods and materials for AC power output, remote control and annunciation comply with applicable codes.
- Flexible conduit and stranded conductors are used for all connections at the generator set. Wiring for remote control and annunciation is run in separate conduit from AC wiring.
- Remote control and annunciation function as intended. All accessories, such as motorized air dampers, function properly.
- The battery charger and engine coolant heater are powered by the normal source and function properly.
- All operators have been thoroughly briefed on the Operator's Manual and its safety precautions—especially concerning the danger of carbon monoxide gas—and can demonstrate how to operate, exercise, maintain and troubleshoot the generator set as explained therein.
- The generator set is properly sized for the application and the loads are balanced across the three phases.
- All generator set access covers and safety shields are secure.
- The control panel switch is in the **REMOTE** position for automatic standby service.

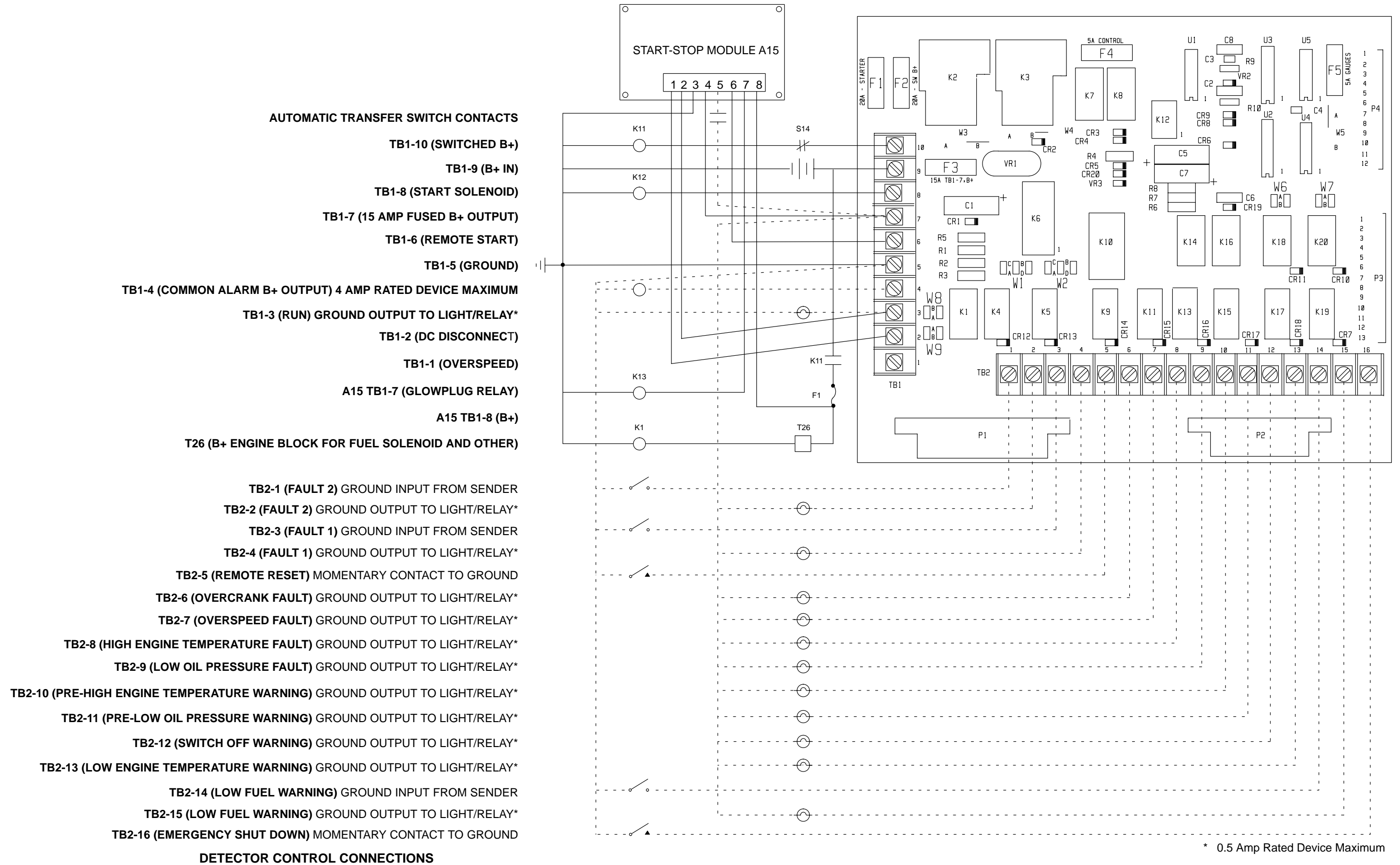

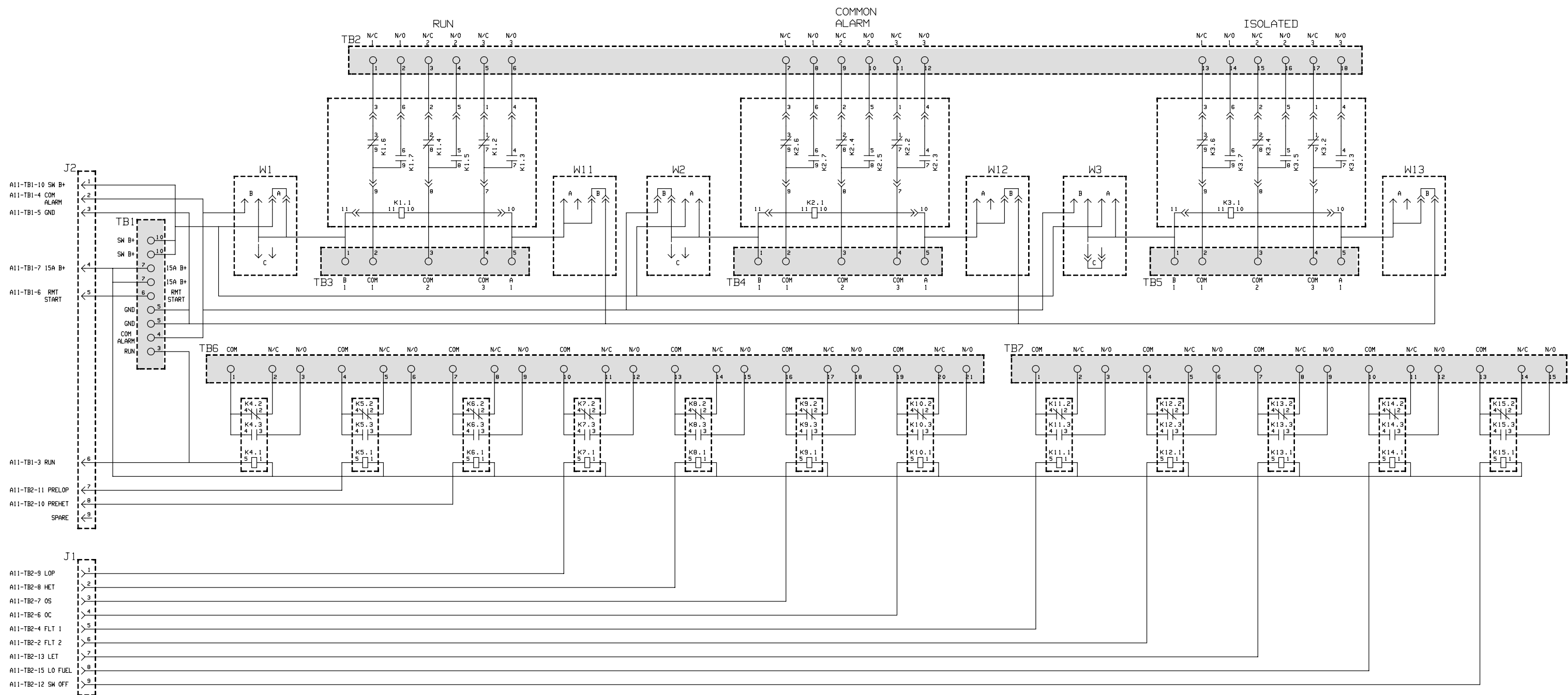

THE TERMINALS IN THE SHADED BOXES ARE FOR CUSTOMER CONNECTIONS

DETECTOR CONTROL—AUXILIARY RELAY BOARD CONNECTIONS

Cummins Power Generation
1400 73rd Avenue N.E.
Minneapolis, MN 55432
1-800-888-6626
763-574-5000 International Use
Fax: 763-528-7229

Cummins is a registered trademark of Cummins Inc.

