

STAMFORD®

BCA162D - Technical Data Sheet

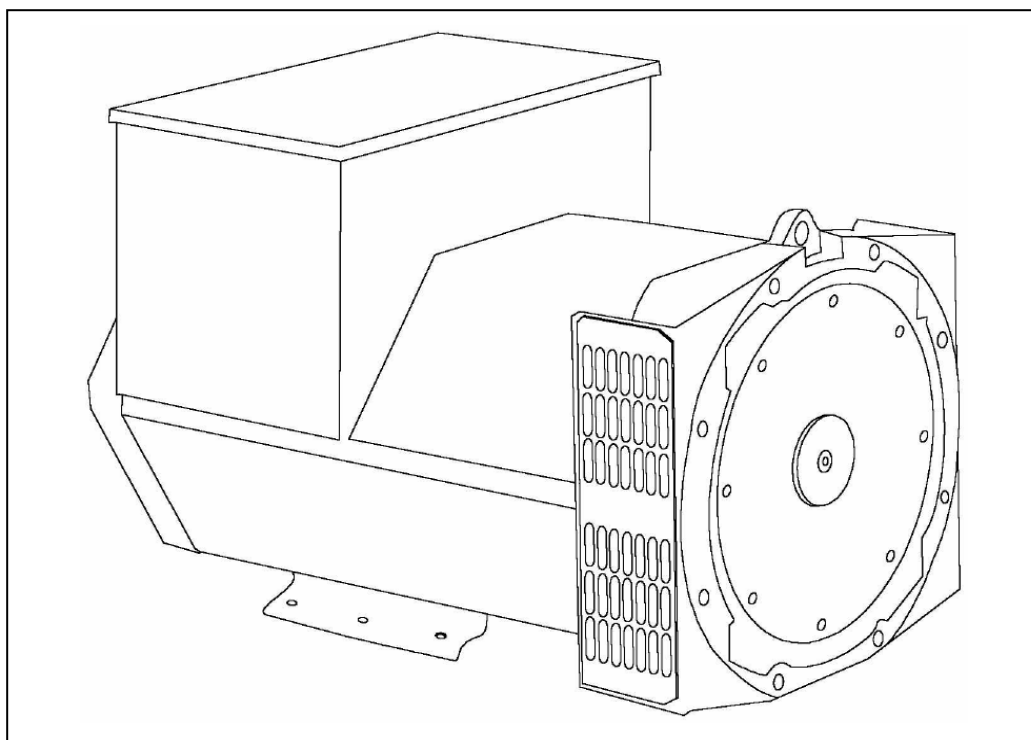

BCA162D

SPECIFICATIONS & OPTIONS

STAMFORD

STANDARDS

Newage Stamford industrial generators meet the requirements of BS EN 60034 and the relevant section of other international standards such as BS5000, VDE 0530, NEMA MG1-32, IEC34, CSA C22.2-100, AS1359.

Other standards and certifications can be considered on request.

VOLTAGE REGULATORS

SX460 AVR - STANDARD

With this self excited control system the main stator supplies power via the Automatic Voltage Regulator (AVR) to the exciter stator. The high efficiency semiconductors of the AVR ensure positive build-up from initial low levels of residual voltage.

The exciter rotor output is fed to the main rotor through a three phase full wave bridge rectifier. This rectifier is protected by a surge suppressor against surges caused, for example, by short circuit.

AS440 AVR

With this self-excited system the main stator provides power via the AVR to the exciter stator. The high efficiency semi-conductors of the AVR ensure positive build-up from initial low levels of residual voltage.

The exciter rotor output is fed to the main rotor through a three-phase full-wave bridge rectifier. The rectifier is protected by a surge suppressor against surges caused, for example, by short circuit or out-of-phase paralleling.

The AS440 will support a range of electronic accessories, including a 'droop' Current Transformer (CT) to permit parallel operation with other ac generators.

WINDINGS & ELECTRICAL PERFORMANCE

All generator stators are wound to 2/3 pitch. This eliminates triplen (3rd, 9th, 15th ...) harmonics on the voltage waveform and is found to be the optimum design for trouble-free supply of non-linear loads. The 2/3 pitch design avoids excessive neutral currents sometimes seen with higher winding pitches, when in parallel with the mains. A fully connected damper winding reduces oscillations during paralleling. This winding, with the 2/3 pitch and carefully selected pole and tooth designs, ensures very low waveform distortion.

TERMINALS & TERMINAL BOX

Standard generators are 3-phase reconnectable with 12 ends brought out to the terminals, which are mounted on a cover at the non-drive end of the generator. A sheet steel terminal box contains the AVR and provides ample space for the customers' wiring and gland arrangements. It has removable panels for easy access.

SHAFT & KEYS

All generator rotors are dynamically balanced to better than BS6861:Part 1 Grade 2.5 for minimum vibration in operation.

INSULATION/IMPREGNATION

The insulation system is class 'H'.

All wound components are impregnated with materials and processes designed specifically to provide the high build required for static windings and the high mechanical strength required for rotating components.

QUALITY ASSURANCE

Generators are manufactured using production procedures having a quality assurance level to BS EN ISO 9001.

The stated voltage regulation may not be maintained in the presence of certain radio transmitted signals. Any change in performance will fall within the limits of Criteria 'B' of EN 61000-6-2:2001. At no time will the steady-state voltage regulation exceed 2%.

NB Continuous development of our products entitles us to change specification details without notice, therefore they must not be regarded as binding.

Front cover drawing typical of product range.

BCA162D



WINDING 311

CONTROL SYSTEM	SELF EXCITED		
A.V.R.	STANDARD SX460	OPTIONAL AS440	
VOLTAGE REGULATION	± 1.0 %	± 1.0 %	
SUSTAINED SHORT CIRCUIT	SELF EXCITED MACHINES DO NOT SUSTAIN A SHORT CIRCUIT CURRENT		

INSULATION SYSTEM	CLASS H
PROTECTION	IP23
RATED POWER FACTOR	0.8
STATOR WINDING	DOUBLE LAYER CONCENTRIC
WINDING PITCH	TWO THIRDS
WINDING LEADS	12
STATOR WDG. RESISTANCE	1.35 Ohms PER PHASE AT 22°C SERIES STAR CONNECTED
ROTOR WDG. RESISTANCE	0.868 Ohms at 22°C
EXCITER STATOR RESISTANCE	18 Ohms at 22°C
EXCITER ROTOR RESISTANCE	0.128 Ohms PER PHASE AT 22°C
R.F.I. SUPPRESSION	BS EN 61000-6-2 & BS EN 61000-6-4, VDE 0875G, VDE 0875N. refer to factory for others
WAVEFORM DISTORTION	NO LOAD < 1.5% NON-DISTORTING BALANCED LINEAR LOAD < 5.0%
MAXIMUM OVERSPEED	4500 Rev/Min
BEARING NON-DRIVE END	BALL. 6306 - 2RS. (ISO)
WEIGHT COMP. GENERATOR	83 kg
WEIGHT WOUND STATOR	29.02 kg
WEIGHT WOUND ROTOR	21.56 kg
WR ² INERTIA	TBA
SHIPPING WEIGHTS in a crate	93 kg
PACKING CRATE SIZE	64 x 54 x 72 (cm)

	50 Hz				60 Hz			
TELEPHONE INTERFERENCE	THF<2%				TIF<50			
COOLING AIR	0.19 m³/sec 398 cfm				0.23 m³/sec 490 cfm			
VOLTAGE SERIES STAR	380/220	400/231	415/240	440/254	416/240	440/254	460/266	480/277
VOLTAGE PARALLEL STAR	190/110	200/115	208/120	220/127	208/120	220/127	230/133	240/138
VOLTAGE SERIES DELTA	220/110	230/115	240/120	254/127	240/120	254/127	266/133	277/138
kVA BASE RATING FOR REACTANCE VALUES	12.5	12.5	12.5	12	14.7	15.6	15.6	15.6
X _d DIR. AXIS SYNCHRONOUS	2.827	2.551	2.370	2.024	3.362	3.189	2.918	2.680
X' _d DIR. AXIS TRANSIENT	0.286	0.258	0.240	0.205	0.339	0.321	0.294	0.270
X'' _d DIR. AXIS SUBTRANSIENT	0.179	0.161	0.150	0.128	0.213	0.202	0.185	0.170
X _q QUAD. AXIS REACTANCE	1.407	1.270	1.180	1.008	1.669	1.583	1.448	1.330
X'' _q QUAD. AXIS SUBTRANSIENT	0.322	0.291	0.270	0.231	0.389	0.369	0.338	0.310
X _L LEAKAGE REACTANCE	0.113	0.102	0.095	0.081	0.138	0.131	0.120	0.110
X ₂ NEGATIVE SEQUENCE	0.274	0.248	0.230	0.196	0.326	0.309	0.283	0.260
X ₀ ZERO SEQUENCE	0.119	0.108	0.100	0.085	0.151	0.143	0.131	0.120

REACTANCES ARE SATURATED

VALUES ARE PER UNIT AT RATING AND VOLTAGE INDICATED

T' _d TRANSIENT TIME CONST.	0.012 s
T'' _d SUB-TRANSTIME CONST.	0.003 s
T' _{do} O.C. FIELD TIME CONST.	0.225 s
T _a ARMATURE TIME CONST.	0.004 s
SHORT CIRCUIT RATIO	1/X _d

50
Hz

BCA162D
Winding 311

STAMFORD

THREE PHASE EFFICIENCY CURVES

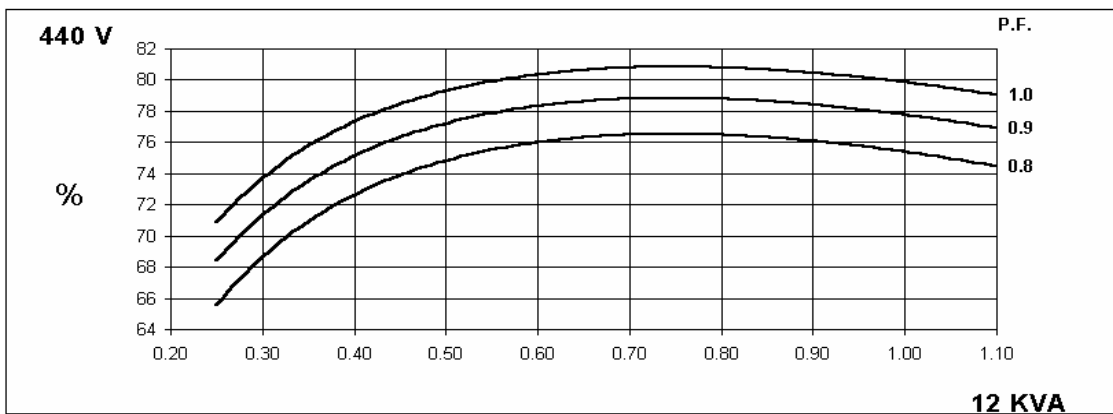
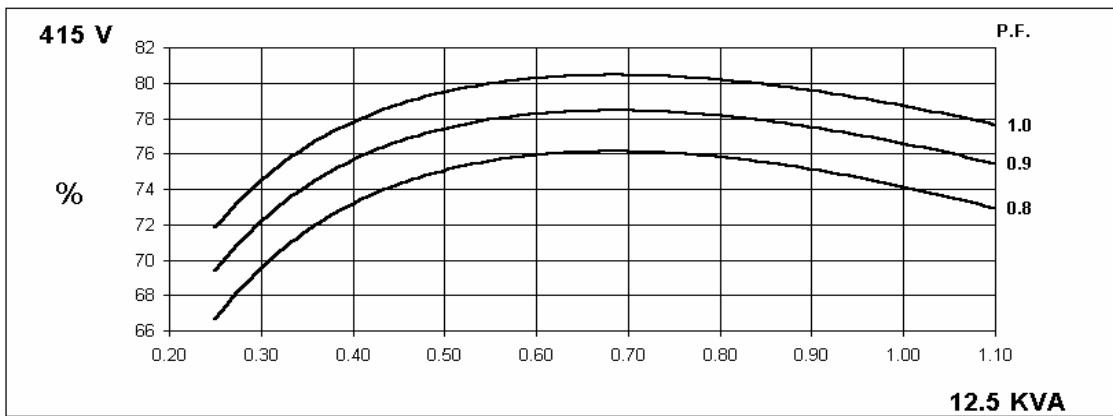
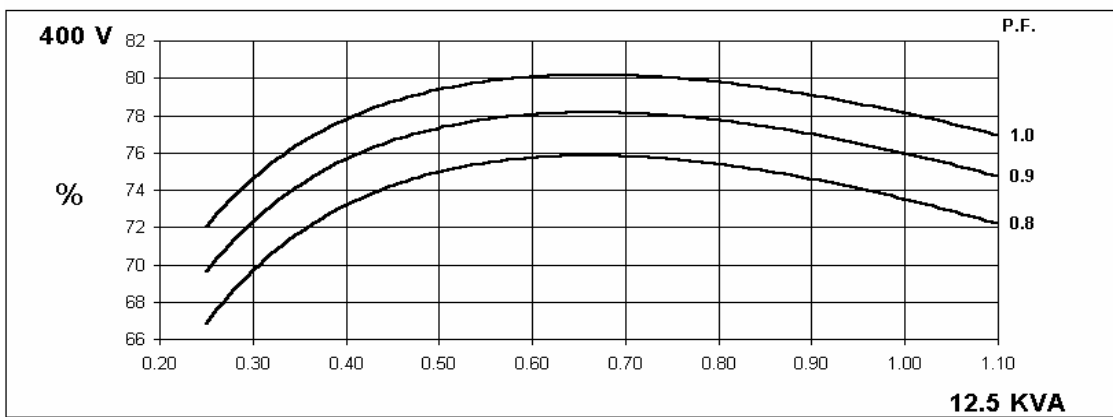
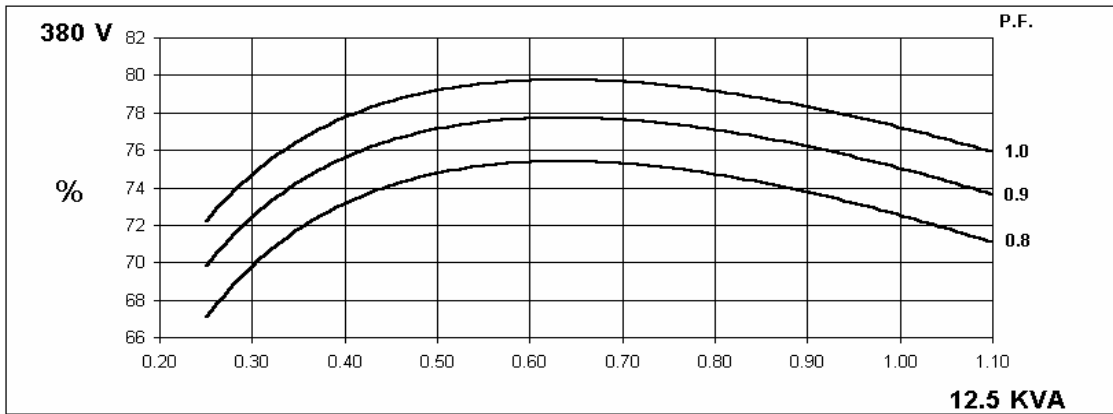

60
Hz

BCA162D
Winding 311

STAMFORD

THREE PHASE EFFICIENCY CURVES

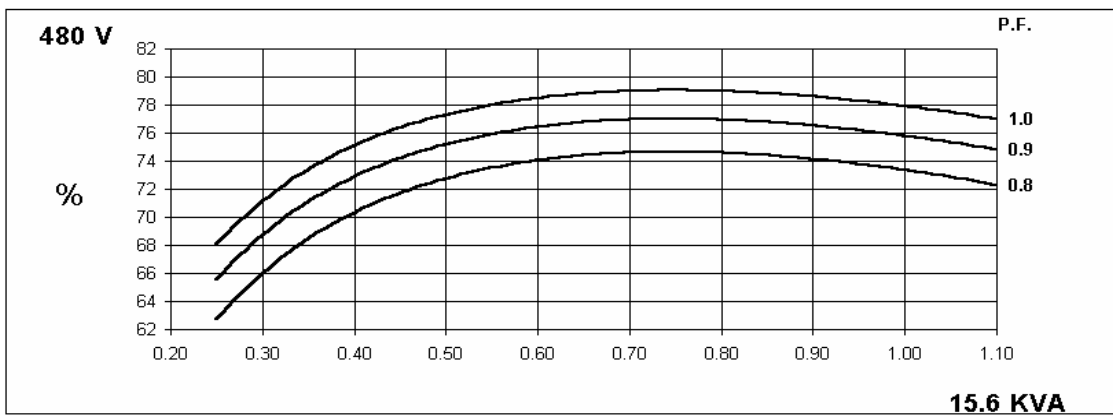
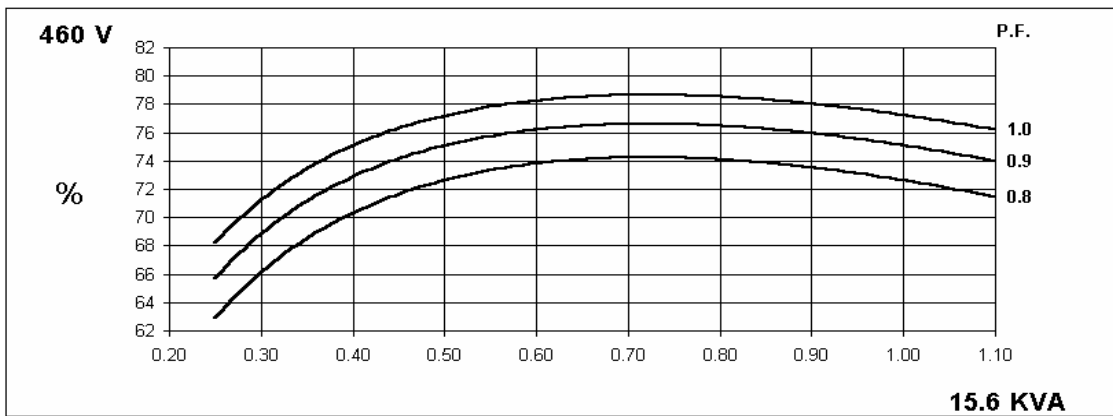
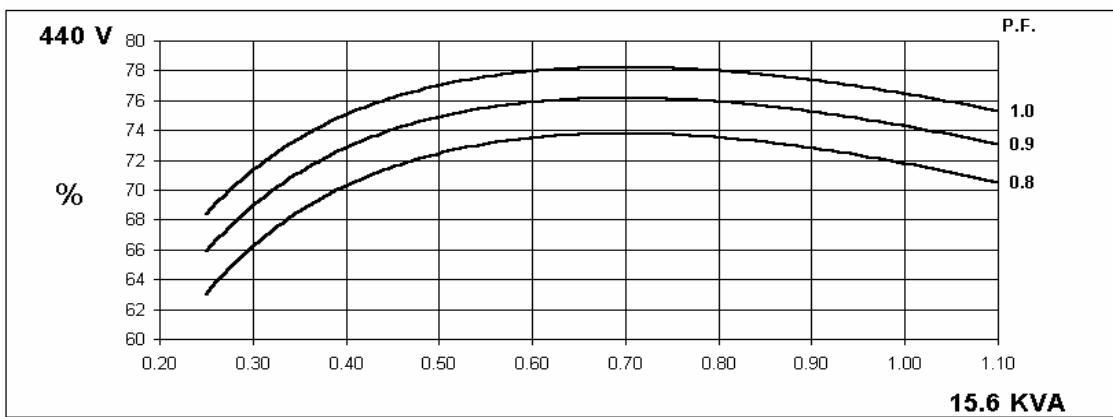
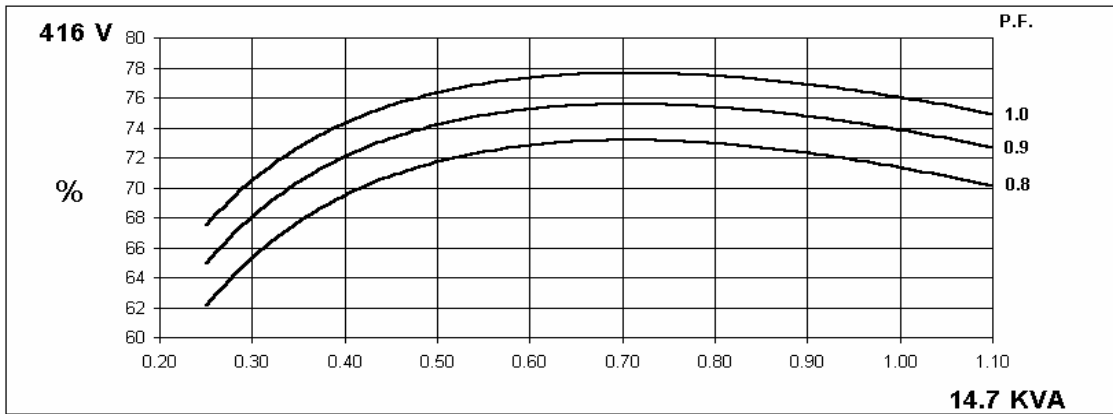

Locked Rotor Motor Starting Curve

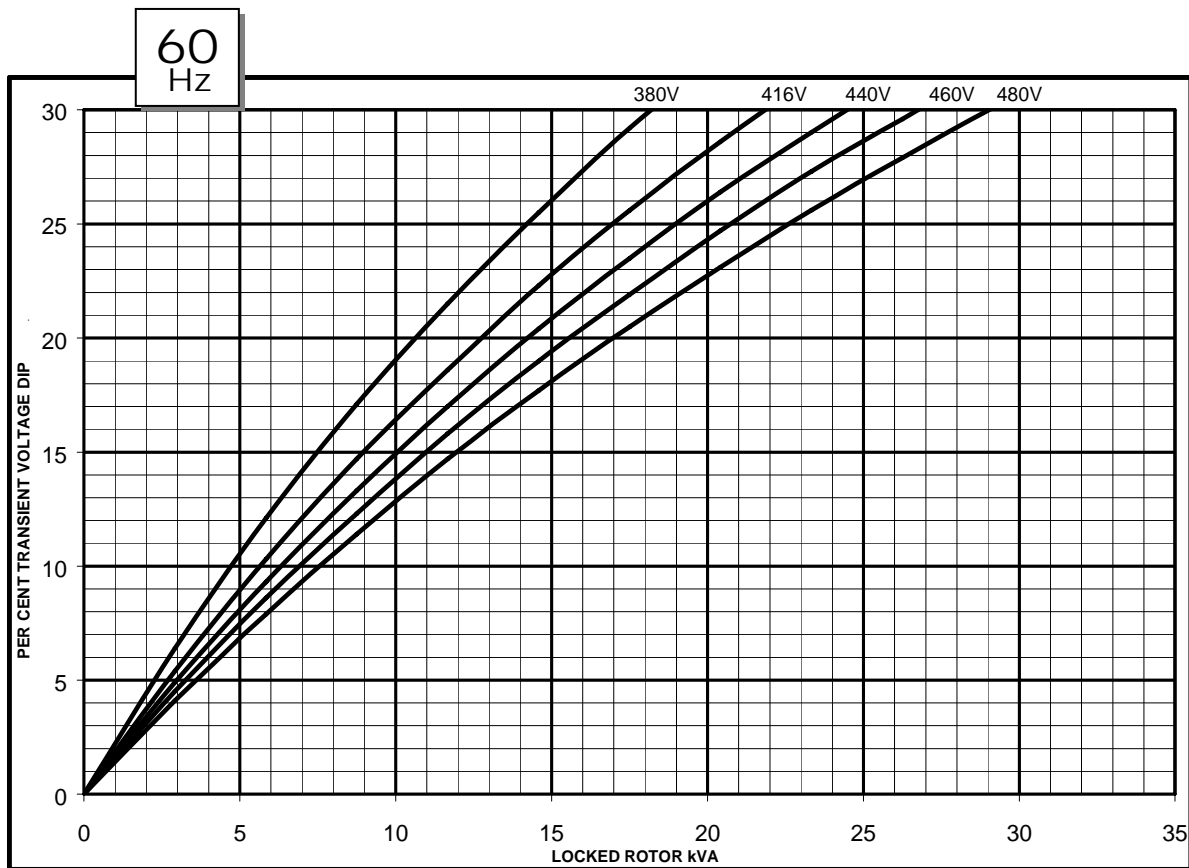
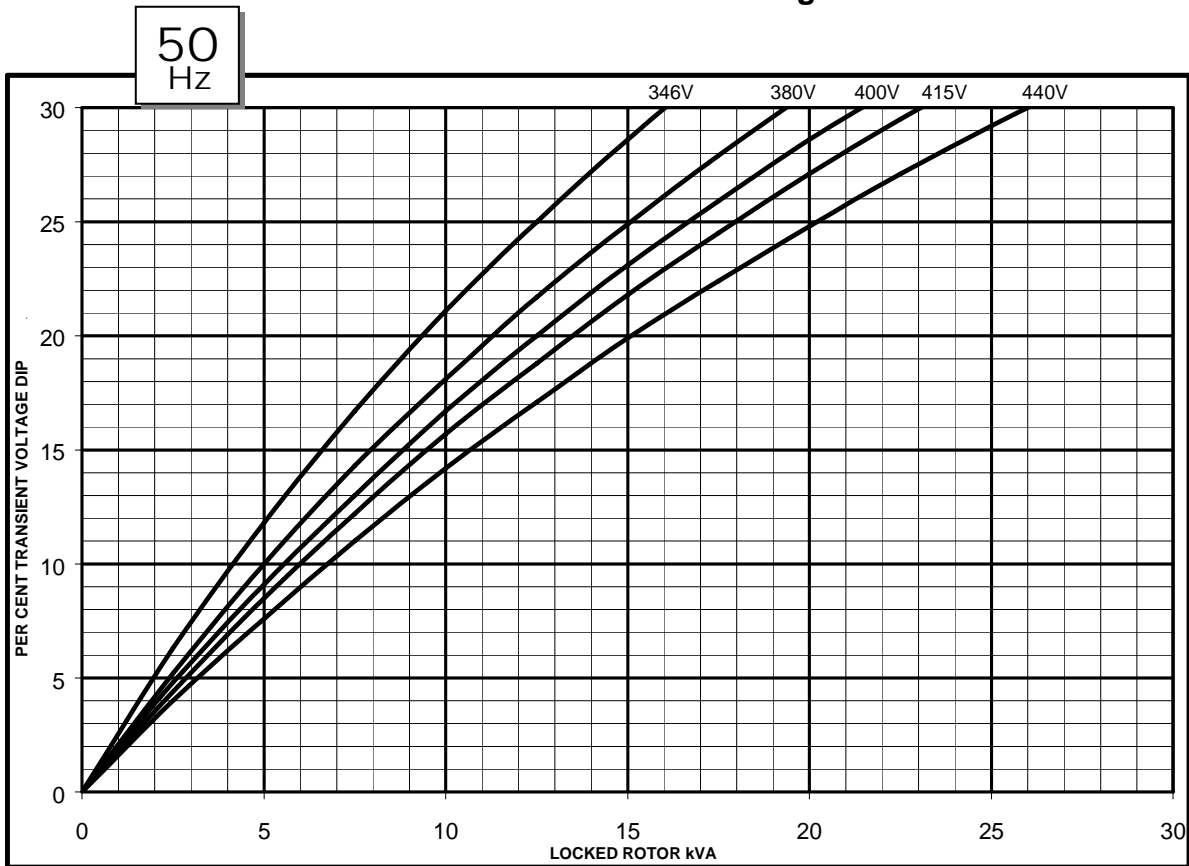

Page left blank intentionally

BCA162D
Winding 311 / 0.8 Power Factor

RATINGS

Class - Temp Rise	Cont. F - 105/40°C				Cont. H - 125/40°C				Standby - 150/40°C				Standby - 163/27°C				
50 Hz	Series Star (V)	380	400	415	440	380	400	415	440	380	400	415	440	380	400	415	440
	Parallel Star (V)	190	200	208	220	190	200	208	220	190	200	208	220	190	200	208	220
	Series Delta (V)	220	230	240	254	220	230	240	254	220	230	240	254	220	230	240	254
kVA	11.5	11.5	11.5	11.0	12.5	12.5	12.5	12.0	N/A	N/A							
kW	9.2	9.2	9.2	8.8	10.0	10.0	10.0	9.6									
Efficiency (%)	73.6	74.4	75.0	76.0	72.6	73.5	74.2	75.4									
kW Input	12.5	12.4	12.3	11.6	13.8	13.6	13.5	12.7									

60 Hz	Series Star (V)	416	440	460	480	416	440	460	480	416	440	460	480	416	440	460	480
	Parallel Star (V)	208	220	230	240	208	220	230	240	208	220	230	240	208	220	230	240
	Series Delta (V)	240	254	266	277	240	254	266	277	240	254	266	277	240	254	266	277
kVA	13.6	14.4	14.4	14.4	14.7	15.6	15.6	15.6	N/A	N/A							
kW	10.9	11.5	11.5	11.5	11.8	12.5	12.5	12.5									
Efficiency (%)	72.1	72.6	73.4	74.0	71.4	71.8	72.6	73.4									
kW Input	15.1	15.9	15.7	15.6	16.5	17.4	17.2	17.0									

DIMENSIONS

