



# Operator/Installation Manual

Our energy working for you.™



**Power  
Generation**

## Controller

PowerCommand® Control 0300  
(PCC0300)

# Control Operation

## CONTROL FEATURES

The PowerCommand® Control 0300 (PCC0300) shown in Figure 1 includes the following:

- Off / Manual Mode/ Auto Mode Key Switch
- Start Button
- Event Lamps – Six lamps are used to inform the operator of the genset events listed in Table 1.
- Digital Display – Engine run time (in hours) is displayed.

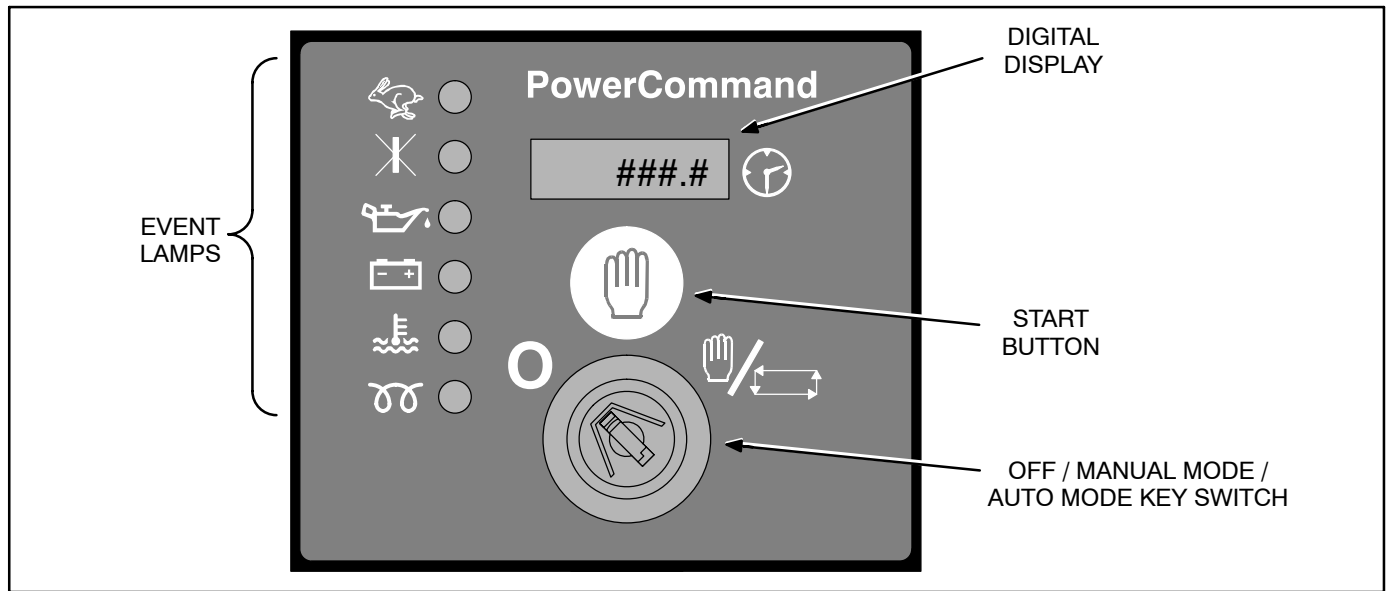









FIGURE 1. PCC0300 FEATURES

TABLE 1. CONTROL LAMPS



LAMP ICON	EVENT	EVENT TYPE	DESCRIPTION
	Overspeed/ Underspeed	Shutdown Fault	This lamp lights if the engine speed exceeds the limit of 14% above the nominal frequency, indicating an overspeed fault. This lamp flashes when the engine speed drops below 20 Hz, indicating an underspeed fault.
	Fail to Start	Shutdown Fault	This lamp lights if the engine fails to start after three attempts.
	Low Oil Pressure	Shutdown Fault	This lamp lights if the control detects that the engine oil pressure has fallen below the limit set by the low oil pressure switch for a specified amount of time.
	Battery Charger Failure	Warning	This lamp lights if the control does not detect any voltage from the warning light terminal on the auxiliary charge alternator.
	High Engine Temperature	Shutdown Fault	This lamp lights if the control detects that the engine coolant temperature has exceeded the limit set by the high engine temperature switch.
	Preheating	Event	This lamp lights to indicate preheating is occurring.

## OPERATION

Either Manual or Auto Mode can be used to start a generator with the PCC0300. The Start button  or a remote start signal and the two-position Key Switch on the control are used to operate in the desired mode.

### Manual Mode

To start the generator set using Manual Mode:

1. Turn the key switch to the  position.
2. Press the Start button .

Once the Start button is pressed, the  lamp lights to indicate preheating has begun.

**NOTE:** This mode of operation does not use a Start Time Delay. Starting commences as soon as the Start button is pressed.

Upon engine start, the Fuel Solenoid is energized and then the Starter Motor is engaged.

When an engine receives a start signal, the engine cranks for 10 seconds. If the engine fails to fire during this cranking attempt, the starter motor is disengaged for 10 seconds. Up to two additional attempts are then made to start the engine. Should the engine fail to start after three attempts, the start sequence is terminated and the Fail to Start lamp  lights.

When the engine fires, the starter motor is disengaged and locked out when 20 Hz is measured from the alternator output.

After the starter motor has disengaged, a hold-off time delay is activated (fixed at 10 seconds), allow-

ing the engine to stabilize without triggering nuisance faults (low oil pressure, high engine temperature, underspeed, and charger failure).

Turning the key to the Stop  position de-energizes the Fuel Solenoid and the generator stops.

### Automatic Mode

To start the genset using Automatic Mode, turn the key switch to the  position. The start sequence is initiated when the remote start input is activated.

After a fixed 5-second start time delay, preheating occurs (fixed at 10 seconds) and the  lamp lights. The Fuel Solenoid energizes and, one second later, the Starter Motor engages.

The engine cranks for 10 seconds. If the engine fails to fire during this cranking attempt, the starter motor is disengaged for 10 seconds. Up to two additional attempts are then made to start the engine. Should the engine fail to start after three attempts, the start sequence is terminated and the Fail to Start lamp  lights.

When the engine fires, the starter motor is disengaged and locked out when 20 Hz is measured from the alternator output.

After the starter motor has disengaged, a hold-off time delay is activated (fixed at 10 seconds), allowing the engine to stabilize without triggering nuisance faults (low oil pressure, high engine temperature, underspeed, and charger failure).

After the Remote Start signal is removed, a Stop time delay (30 seconds) is initiated. Once this time delay has expired, the Fuel Solenoid de-energizes and the generator stops.

## WARNINGS AND SHUTDOWNS

### Warnings

A warning is used to warn the operator of an impending fault.



- Battery Charger Failure – The  lamp lights if the control does not detect any voltage from the warning light terminal on the auxiliary charge alternator.

### Shutdowns

A shutdown fault stops the generator and the appropriate lamp on the front of the PCC0300 lights. When a shutdown fault occurs, the alarm must be cleared and the fault removed to reset the module. This is done by turning the key switch to the Off  position.



- NOTE:** The alarm condition must be rectified before a reset will take place. If the alarm condition remains, it will not be possible to reset the unit. An exception to this is the Low Oil Pressure alarm (and other similar “delayed alarms”), because the oil pressure will be low when the engine is at rest.
- Fail to Start – If the engine does not start after three pre-set attempts, a shutdown occurs and the  lamp lights.
  - Low Oil Pressure – If the control detects that the engine oil pressure has fallen below the limit set

by the low oil pressure switch after the hold-off time delay has expired, a shutdown occurs and the  lamp lights.

- High Engine Temperature – If the control detects that the engine coolant temperature has exceeded the limit set by the high engine temperature switch after the hold-off time delay has expired, a shutdown occurs and the  lamp lights.
- Overspeed – If the engine speed exceeds the pre-set trip level (14% above the nominal frequency), an immediate shutdown occurs and the  lamp lights.

**NOTE:** During a start-up sequence, the overspeed trip level is extended up to 24% above the normal frequency for the duration of the hold-off time delay to allow the extra trip level margin. This is used to prevent nuisance tripping during start-up.

- Underspeed – If the engine speed falls below 20 Hz (fixed) after the hold-off time delay has expired, a shutdown is initiated and the  lamp flashes.

**NOTE:** The  icon is used to indicate both underspeed and overspeed. A flashing  icon indicates underspeed. A steady  icon indicates overspeed.

## SETTINGS

### Fixed Settings

The settings listed in Table 2 are set at the factory and cannot be adjusted.

**TABLE 2. FIXED SETTINGS**

FUNCTION	SETTING
Crank disconnect	20 Hz
Underspeed	20 Hz
Overspeed	57 Hz (50 Hz nominal) 68 Hz (60 Hz nominal)
Remote start time delay	5 Seconds
Preheat time delay	10 Seconds
Crank period	10 Seconds
Rest period between cranks	10 Seconds
Safety time delay	10 Seconds
Remote stop time delay	30 Seconds

### Adjustable Setting

The PCC0300 includes a switch located on the bottom of the control that is used to select 50 or 60 Hz nominal frequency (see Figure 2). When the switch is set to the left position, 60 Hz is selected. When the switch is set to the right position, 50 Hz is selected.

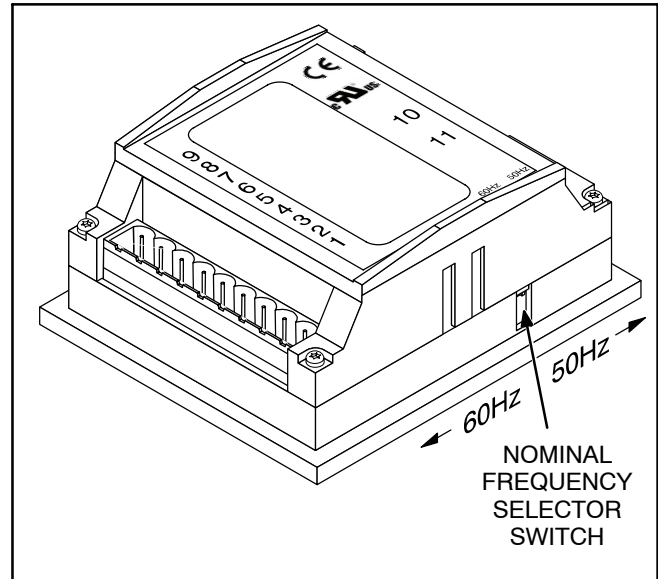

**FIGURE 2. 50/60 HZ SELECTOR SWITCH**

## TERMINAL PIN DESCRIPTIONS

PIN NO.	DESCRIPTION	CABLE SIZE	NOTES
1	Ground	1.0mm	Connected to plant battery negative
2	B+	1.0mm	Connected to plant battery positive (Recommended 2 amp fuse)
3	Fuel Relay Output	0.5mm	Used to operate the fuel solenoid control relay
4	Starter Relay Output	0.5mm	Used to operate the cranking control relay
5	Preheat Output Relay	0.5mm	Used to operate the preheat control relay
6	Remote Start Input	0.5mm	Switch to negative to start the genset
7	Charge Fail Input/Excitation Output	1.0mm	Must NOT be connected to the plant supply negative if not used
8	Low Oil Pressure Input	0.5mm	Switch to negative on fault
9	High Engine Temperature Input	0.5mm	Switch to negative on fault
10	Alternator Input L1	1.0mm	2 amp fuse
11	Alternator Input N	1.0mm	

**NOTE:** All of the outputs are solid state, rated at 1.2 amps 8 volts to 35 volts DC, and switch to battery negative when active.

# Control Installation

## INSTALLATION

Refer to Figure 3 to for dimensions required to install the control. Two mounting clamps are needed to secure the control to a panel (see View A). Wiring information is included in Figure 4.

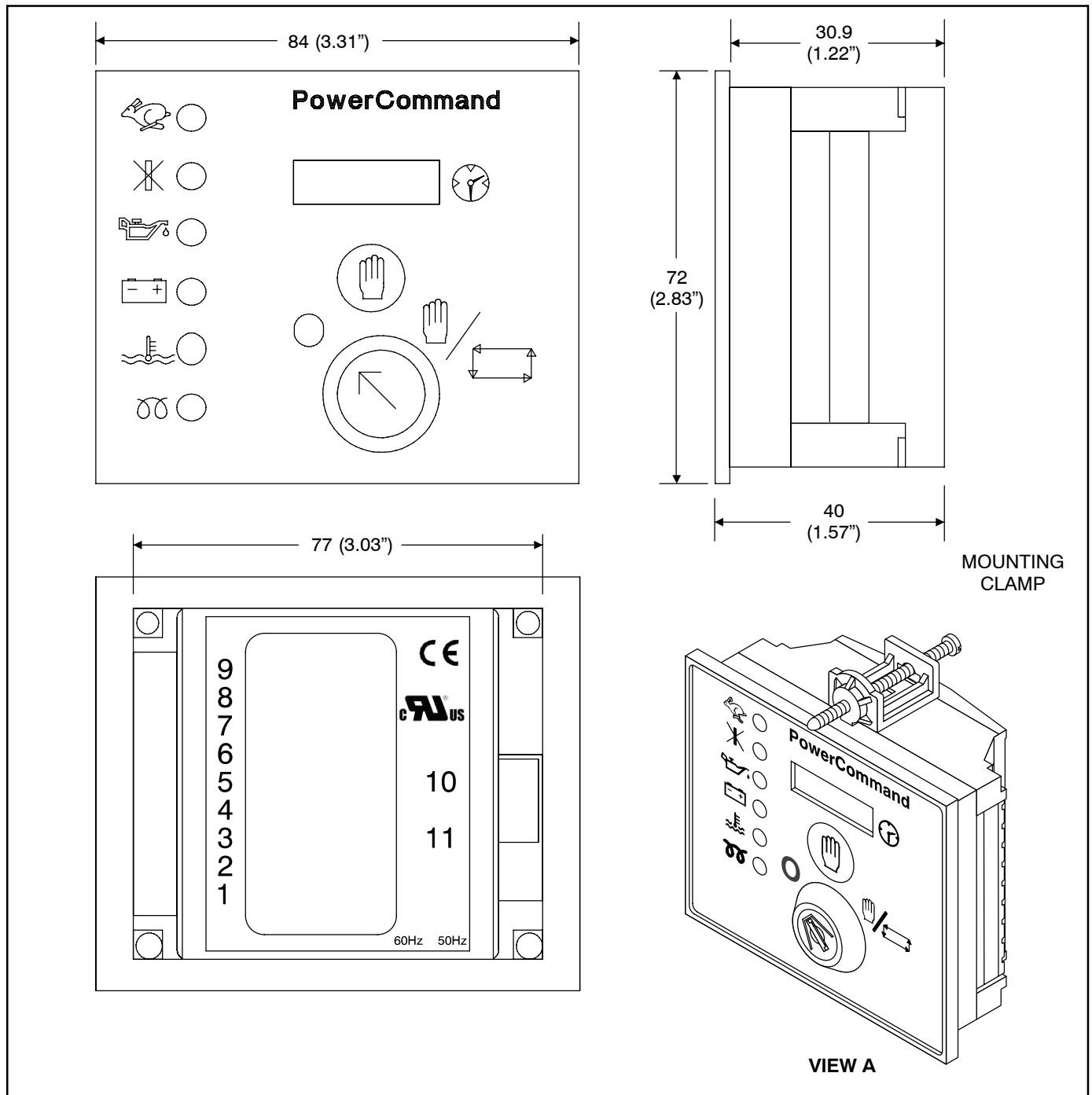

FIGURE 3. CONTROL DIMENSIONS

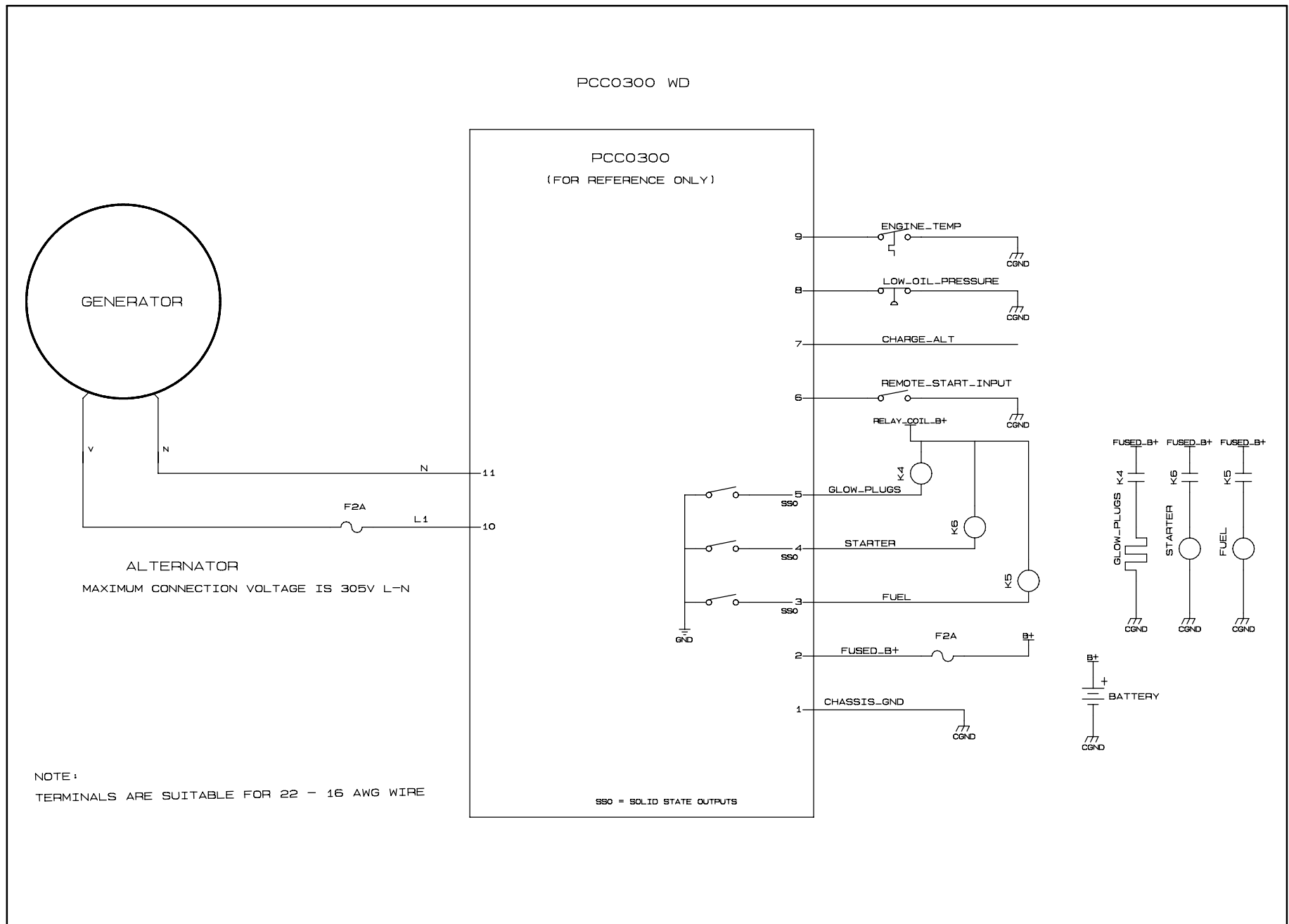

FIGURE 4. CONTROL WIRING DIAGRAM

**Cummins Power Generation**

1400 73rd Ave. NE  
Minneapolis, MN 55432 USA

Phone 1 763 574 5000

Toll-free 1 800 888 6626

Fax 1 763 574 5298

Email [ask.powergen@cummins.com](mailto:ask.powergen@cummins.com)

[www.cumminspower.com](http://www.cumminspower.com)

Cummins®, the "C" logo, and "Our energy working for you." are trademarks of Cummins Inc.

©2007 Cummins Power Generation, Inc. All rights reserved.



Redistribution or publication of this document by any means, is strictly prohibited.