



Operator Manual

Performance you rely on.™



50 Hz Portable Inverter Generator Set

EGMBH / P1700i



**For Parts Ordering and Technical Support
Please Contact**

**Cummins
50 – 52 Diagonal Road
Pooraka
South Australia 5082**

**Parts phone: 08 8368 4358
Service phone: 08 8368 4308**

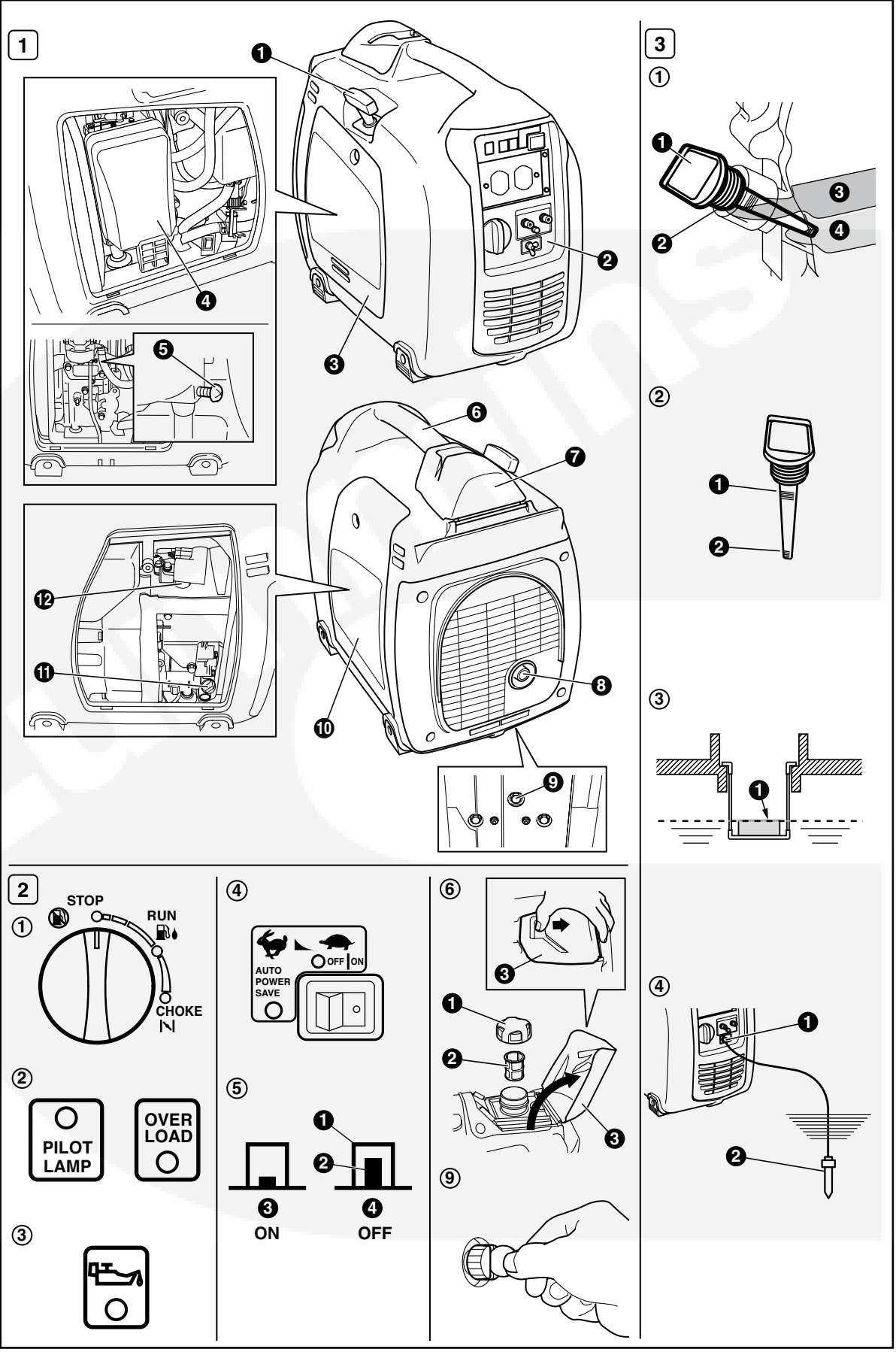

4

1

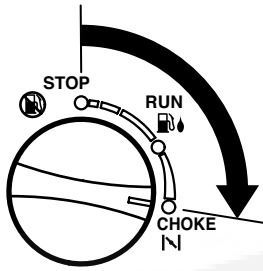

2



3

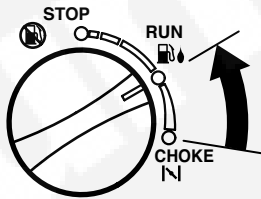

4

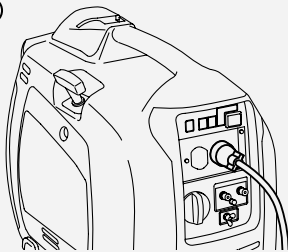

5

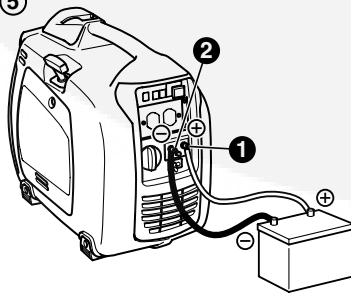

6

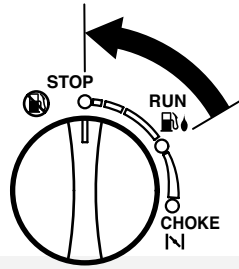

7

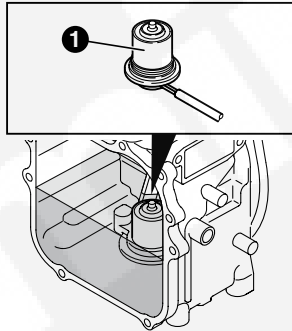

5

1

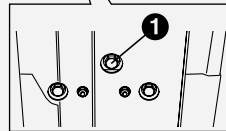
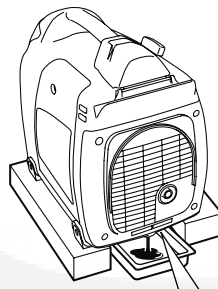

2

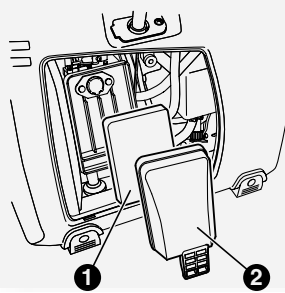

3

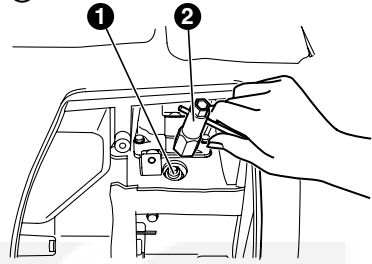

4

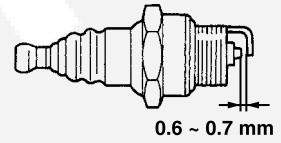

6

1



2

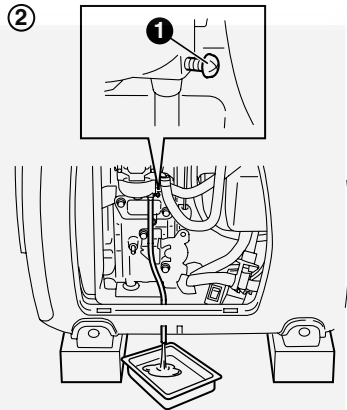

®

FOREWORD

Thank you very much for purchasing a **CUMMINS GENERATOR**.

This manual covers operation and maintenance of the **CUMMINS GENERATOR**.

This **CUMMINS GENERATOR** can be used for general electrical equipments, appliances, lamps, tools as an AC power source. With regards to DC application, the terminals are used only for charging 12 volt battery. Never use this generator for any other purposes.

Please take a moment to familiarize yourself with the proper operation and maintenance procedures in order to maximize the safe and efficient use of this product.

Keep this owner's manual at hand, so that you can refer to it at any time.

Due to constant efforts to improve our products, certain procedures and specifications are subject to change without notice.

When ordering spare parts, always give us the **MODEL, PRODUCTION NUMBER (PROD No.)** and **SERIAL NUMBER (SER No.)** of your Product.

Please fill in the following blanks after checking the production number on your product.
(Location of label is different depending on the product model.)

PROD NO.									

SER NO.					

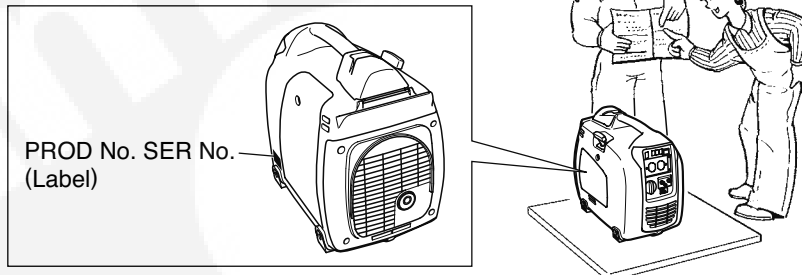

CONTENTS

1. SAFETY PRECAUTIONS	6
2. COMPONENTS	9
3. CONTROLS AND INDICATORS	9
4. PRE-OPERATION CHECKS	10
5. OPERATING PROCEDURES	12
6. WATTAGE INFORMATION	14
7. MAINTENANCE SCHEDULE	15
8. "HOW-TO" MAINTENANCE	16
9. PERIODIC OPERATION AND INSPECTION	17
10. TRANSPORTING	17
11. PREPARATION FOR STORAGE	18
12. TROUBLESHOOTING	18
13. SPECIFICATIONS	19
14. WIRING DIAGRAM	20

NOTE Please refer to the illustrations on the back page of the front cover or back cover for Fig. ① to ⑥ indicated in the sentence.

1. SAFETY PRECAUTIONS

Please make sure you review each precaution carefully.
Pay special attention to statement preceded by the following words.

⚠ WARNING “WARNING” indicates a strong possibility of severe personal injury or loss of life if instructions are not followed.

⚠ CAUTION “CAUTION” indicates a possibility of personal injury or equipment damage if instructions are not followed.

⚠ WARNING

Do not operate the generator near gasoline or gaseous fuel because of the potential danger of explosion or fire.
Do not fill the fuel tank with fuel while the engine is running. Do not smoke or use open flame near the fuel tank. Be careful not to spill fuel during refueling. If fuel is spilt, wipe it off and let dry before starting the engine.



⚠ WARNING

Do not place in flammables near the generator.
Be careful not to place fuel, matches, gunpowder, oily cloths, straw, trash, or any other in flammables near the generator.

⚠ WARNING

Do not operate the generator inside a room, cave, tunnel, or other insufficiently ventilated area. Always operate it in a well-ventilated area, otherwise the engine may become overheated, and the poisonous carbon monoxide gas contained in the exhaust gases will endanger human lives. Keep the generator at least 1 meter (3 feet) away from any structure or building during use.
If the generator must be used indoors, the area must be well-ventilated and extreme caution must be taken regarding the discharge of exhaust gases.

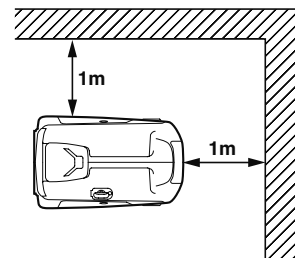

⚠ WARNING

Do not enclose the generator nor cover it with a box.
The generator has a built-in forced air cooling system, and may become overheated if it is enclosed.
If generator has been covered to protect it from the weather during non use, be sure to remove it and keep it well away from the area during generator use.

⚠ WARNING

Operate the generator on a level surface.
It is not necessary to prepare a special foundation for the generator.
However, the generator will vibrate on an irregular surface, so choose a level place without surface irregularities.
If the generator is tilted or moved during operation, fuel may spill and / or the generator may tip over, causing a hazardous situation.
Proper lubrication cannot be expected if the generator is operated on a steep incline or slope. In such a case, piston seizure may occur even if the oil is above the upper level.

⚠ WARNING

Pay attention to the wiring or extension cords from the generator to the connected device.
If the wire is under the generator or in contact with a vibrating part, it may break and possibly cause a fire, generator burnout, or electric shock hazard.
Replace damaged or worn cords immediately.



⚠ WARNING

Do not operate in rain, in wet or damp conditions, or with wet hands.
The operator may suffer severe electric shock if the generator is wet due to rain or snow.

⚠ WARNING

If wet, wipe and dry it well before starting. Do not pour water directly over the generator, nor wash it with water.

⚠ WARNING

Be extremely careful that all necessary electrical grounding procedures are followed during each and every use. Failure to do so can be fatal.

⚠ WARNING

Do not contact the generator to a commercial power line. Connection to a commercial power line may short circuit the generator and ruin it or cause electric shock hazard. Use the transfer switch for connecting to domestic circuit.



⚠ WARNING

No smoking while handling the battery. The battery emits flammable hydrogen gas, which can explode if exposed to electric arcing or open flame. Keep the area well-ventilated and keep open flames/sparks away when handling the battery.



⚠ WARNING

Engine becomes extremely hot during and for some time after operation. Keep combustible materials well away from generator area. Be very careful not to touch any parts of the hot engine especially the muffler area or serious burns may result.



⚠ WARNING

Keep children and all bystanders at a safe distance from work areas.

⚠ WARNING

It is absolutely essential that you know the safe and proper use of the power tool or appliance that you intend to use. All operators must read, understand and follow the tool/appliance owners manual. Tool and appliance applications and limitations must be understood. Follow all directions given on labels and warnings. Keep all instruction manuals and literature in a safe place for future reference.

⚠ WARNING

Use only "LISTED" extension cords.
When a tool or appliance is used outdoors, use only extension cords marked "For Outdoor Use". Extension cords, when not in use should be stored in a dry and well ventilated area.

⚠ WARNING

Always switch off generator's AC circuit breaker and disconnect tools or appliances when not in use, before servicing, adjusting, or installing accessories and attachments.

⚠ CAUTION

Make sure the engine is stopped before starting any maintenance, servicing or repair.
Make sure maintenance and repair of the generator set are performed by properly trained personnel only.



Symbols and Meanings

In accordance with the European requirements (EEC Directives), the specified symbols as shown in the following table are used for the products and this instruction manual.

	<i>Read the operator's instruction manual.</i>		<i>Fire, open light and smoking prohibited.</i>
	<i>Stay clear of the hot surface.</i>		<i>Caution, risk of electric shock.</i>
	<i>Exhaust gas is poisonous. Do not operate in an unventilated room.</i>		<i>Do not connect the generator to the commercial power lines.</i>
	<i>Stop the engine before refueling.</i>		<i>HOT, avoid touching the hot area.</i>

	<i>ON (power and Engine)</i>		<i>IN-position of a bistable push control</i>		<i>Engine start (Electric start)</i>
○	<i>OFF (power and Engine)</i>		<i>Protective earth (ground)</i>		<i>Engine stop</i>
~	<i>Alternating current</i>		<i>Fuse</i>		<i>Gasoline</i>
≡	<i>Direct current</i>		<i>Engine oil</i>		<i>Fast</i>
+	<i>Plus ; positive polarity</i>		<i>Add oil</i>		<i>Slow</i>
-	<i>Minus ; negative polarity</i>		<i>Battery charging condition</i>		<i>Fuel start / Open</i>
	<i>OUT-position of a bistable push control</i>		<i>Choke ; cold starting aid</i>		<i>Fuel stop / Close</i>

P_r	<i>Rated power (kW)</i>	COP	<i>Continuous power</i>	$\cos \phi_r$	<i>Rated power factor</i>
f_r	<i>Rated frequency (Hz)</i>	U_r	<i>Rated voltage (V)</i>	I_r	<i>Rated current (A)</i>
H_{max}	<i>Maximum site altitude above sea-level (m)</i>	T_{max}	<i>Maximum ambient temperature (°C)</i>	m	<i>Mass (kg)</i>

2. COMPONENTS (See Fig. 1)

NOTE

Please refer to the illustrations on the back page of the front cover or back cover for Fig. 1 to 6 indicated in the sentence.

- ❶ RECOIL STARTER (HANDLE)
- ❷ CONTROL PANEL
- ❸ SIDE PANEL (L)
- ❹ AIR CLEANER*
- ❺ FUEL DRAIN SCREW
- ❻ CARRING HANDLE
- ❼ TANK CAP COVER
- ❽ EXHAUST OUTLET
- ❾ OIL DRAIN PLUG
- ❿ SIDE PANEL (R)
- ⓫ OIL GAUGE (OIL FILLER)**
- ⓬ SPARK PLUG CAP**

* : Inside the SIDE PANEL (L)

** : Inside the SIDE PANEL (R)

CONTROL PANEL

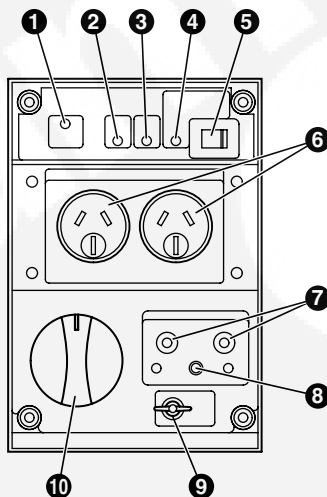

- ❶ PILOT LAMP
- ❷ OVERLOAD LAMP
- ❸ OIL SENSOR LAMP
- ❹ AUTO POWER SAVE LAMP
- ❺ AUTO POWER SAVE SWITCH
- ❻ AC RECEPTACLES
- ❼ DC TERMINALS
- ❽ DC CIRCUIT BREAKER
- ❾ GROUND TERMINAL
- ❿ ENGINE SWITCH

3. CONTROLS AND INDICATORS (See Fig. 2)

ENGINE SWITCH (See Fig. 2-1)

The engine switch is designed for easy operation with the interlocking mechanism between the fuel cock and the choke furnished.

CHOKE 	To start the engine, turn the knob to the position. (Choke valve is closed.)
RUN 	Keep the knob in this position after the engine starts. (The engine can be started with the knob at this position when the engine is warm.)
STOP 	To stop the engine, return the knob to the position. (The fuel cock is closed as well.)

PILOT LAMP and OVERLOAD LAMP (See Fig. 2-2)

These lamps are turned on in the following conditions;
PILOT LAMP (Green) --- The lamp is turned on while generating properly.

OVERLOAD LAMP (Red) --- The lamp is turned on in the overload condition.

* The breaker will be activated after the lamp is turned on for 20 seconds in the 120% electric power condition, and results in no load condition.

* If the lamp is turned on, stop and start the engine again to resume the operation.

OIL SENSOR LAMP (See Fig. 2-3)

When the level of the engine oil falls below the prescribed value, the alarm lamp lights up and the engine stops automatically. When the engine stops due to oil shortage, it can not be started anymore even by pulling the start knob (just the alarm lamp flickers). In such a case, replenish engine oil up to the mouth of the oil filling port.

(Refer to page 6 for details about the oil replenishing procedure).

AUTO POWER SAVE SWITCH AND LAMP (See Fig. 2-4)

With the switch in the “

When using in the heavy load condition, set the switch into the “

When using DC power, turn the switch into the “OFF” position.

DC CIRCUIT BREAKER (See Fig. 2-5)

DC circuit breakers shut off electric current when the current exceeds its limit or a malfunction occurs in the connected appliance.

Check for excessive current consumption or defects in the appliance. After making sure everything is in order, push the button to the " ON " position.

- 1 BUTTON
- 2 KNOB
- 3 IN (ON)
- 4 OUT (OFF)

⚠ CAUTION

If circuit breaker continues to be activated, discontinue use and check generator and/or appliance for malfunction with their respective service representatives.
Never interfere with the operation of the circuit breaker knob or keep pushing it in the "ON" position.

FUEL TANK CAP (See Fig. 2-6)

The fuel tank cap is located behind the cover. To open the cover, lift up with the dent portion depressed backward as shown in the illustration. Remove the fuel tank cap by turning counterclockwise.

- 1 FUEL TANK CAP
- 2 FUEL FILTER SCREEN
- 3 TANK CAP COVER

SIDE PANEL (L.R.) (See Fig. 2-7)

To access the following items for servicing, take the applicable side panel out by removing the screw with screwdriver or coin.

LH-side panel ---- Air cleaner etc.

RH-side panel ---- Oil level gauge, Ignition coil, Spark plug etc.

4. PRE-OPERATION CHECKS

(See Fig. 3)

1. CHECK ENGINE OIL (See Fig. 3-1,2)

Before checking or refilling oil, be sure generator is located on stable and level surface with engine stopped.

- Remove oil filler cap and check the engine oil level.
- If oil level is below the lower level line, refill with suitable oil (see table) to upper level line. Do not screw in the oil filler cap when checking oil level.
- Change oil if contaminated.
(See "How-To" Maintenance.)

Oil capacity 0.4 liters

Recommended engine oil:

Use 4-stroke automotive detergent oil of API service class SE or higher grade (SG, SH or SJ is recommended). SAE 10W-30 or 10W-40 is recommended for general, all-temperature use. If single viscosity oil is used, select the appropriate viscosity for the average temperature in your area.

Single grade	5W						
	10W						
Multigrade	20W						
	#20						
Ambient temperature	#30						
	#40						
	10W-30						
	10W-40						
	-20	-10	0	10	20	30	40°C
	-4	14	32	50	68	86	104°F

2. CHECK ENGINE FUEL

(See Fig. 2-6, 3-3)

⚠ WARNING

Do not refuel while smoking or near open flame or other such potential fire hazards. Otherwise fire accident may occur.

- If fuel level is low, refill with unleaded automotive gasoline.
- Fuel level should never over the RED marking at the inlet portion. (See Fig. 3-3-1)

1 RED MARKING

- Be sure to use the fuel filter screen on the fuel filter neck. (See Fig. 2-6)

- ① FUEL TANK CAP
- ② FUEL FILTER SCREEN
- ③ TANK CAP COVER

Fuel tank capacity 3.5 liters

- When using the generator first time or stopping due the fuel running out, pull the recoil handle several times after filling fuel up to the RED marking at the inlet portion of the fuel tank.

⚠ WARNING

Make sure you review each warning in order to prevent fire hazard.

- Do not refill tank while engine is running or hot.
- Before filling fuel, turn the engine switch into "  " (STOP) position.
- Be careful not to admit dust, dirt, water or other foreign objects into fuel.
- Wipe off spilt fuel thoroughly before starting engine.
- Keep open flames away.

3. CHECKING COMPONENT PARTS

Check following items before starting engine:

- Fuel leakage from fuel hose, etc.
- Bolts and nuts for looseness.
- Components for damage or breakage.
- Generator not resting on or against any adjacent wiring.

4. CHECK GENERATOR SURROUNDINGS.

- When listening the radio near by the generator, the radio sound may be disturbed on account of the radio wave condition and the radio performance.

⚠ WARNING

Make sure you review each warning in order to prevent fire hazard.

- Keep area clear of in flammables or other hazardous materials.
- Keep generator at least 1 meter away from buildings or other structures.
- Only operate generator in a dry, well ventilated area.
- Keep exhaust pipe clear of foreign objects.
- Keep generator away from open flame. No smoking!
- Keep generator on a stable and level surface.
- Do not block generator air vents with paper or other material.

5. GROUNDING THE GENERATOR

- To ground the generator to the earth, connect the grounding lug of the generator to the grounding spike driven into the earth or to the conductor which has been already grounded to the earth. (See Fig. 3-4)
- If such grounding conductor or grounding electrode is unavailable, connect the grounding lug of the generator to the grounding terminal of the using electric tool or appliance. (See Fig. 3-4)

- ① GROUND TERMINAL
- ② GROUNDING SPIKE



5. OPERATING PROCEDURES

(See Fig. 4)

1. STARTING THE GENERATOR

⚠ CAUTION

Check the oil level before each operations as outlined on page 6.

- (a) Make sure the appliance is disconnected.
- (b) Turn engine switch to "N" (CHOKE) position.
(When engine is warm or temperature is high, start engine with the switch at "R" (RUN) position.) (See Fig. 4-1)

⚠ CAUTION

- Do not connect defective appliances including lines and plugs.
- Be sure appliances are not connected to generator when starting up. Starting the generator with an appliance connected could result in damage to the generator and/or appliance and in personal injury.

- (c) Pull the starter handle slowly until passing the compression point (resistance will be felt), then return the handle to its original position and pull briskly. (See Fig. 4-2)
 - ① RECOIL STARTER HANDLE
 - ② PULL BRISKLY
- (d) After starting, allow the starter handle to return to its original position with the handle still in your hand.

NOTE

When engine fails to start after several attempts, repeat the starting procedures mentioned above with the engine switch placed at "R" (RUN) position.

- (e) After 20 to 30 seconds of warm-up is completed, turn the engine switch to "R" (RUN) position. (See Fig. 4-3)
- (f) Make sure the pilot lamp is on. This indicates that the generator is properly operating.

NOTE

Please consult with the authorized CUMMINS dealer if the pilot lamp is turned off during the proper operation.

2. USING ELECTRIC POWER

⚠ WARNING

- Make sure that the appliance is switched OFF before connecting it to the generator.
- Do not move the generator while it is running.
- Be sure to ground the generator if the connected appliance is grounded. Failure to ground unit may lead to electrical shock.

(1) AC APPLICATION (See Fig. 4-4)

- (a) Make sure the pilot lamp is turned on.
- (b) Turn off the switch(es) of the electrical appliance(s) before connecting to the generator.
- (c) Insert the plug(s) of the electrical appliance(s) into the receptacle.

⚠ WARNING

- Be sure to ground the generator if the connected electrical device is grounded.
- Failure to ground unit could lead to electrical spark.

⚠ CAUTION

Do not put foreign objects into the plug receptacle.

- Check the amperage of the receptacles, and be sure not to take a current exceeding the specified amperage.
- Be sure that the total wattage of all appliances dose not exceed the rated output of the generator.

NOTE

If the generator is stopped with the overload pilot lamp turned on, the generator will be in the overload condition and/or the electrical appliance(s) would be out of order. In this case, stop the engine immediately and check the appliance and/or generator for overloading. After the check and remedy, restarting the engine will resume displaying in the normal manner.

- (d) Turn on the switch of the appliance.

(2) DC APPLICATION (See Fig. 4-5)

The DC terminal is used only for charging 12 volt batteries. It provides up to 12V-8.3A (100W) of maximum power.

- ❶ Positive terminal (RED)
- ❷ Negative terminal (BLACK)

CONNECTION OF CABLE :

- Connect positive terminal (red) on generator to positive (+) terminal on battery.
- Connect negative terminal (black) on generator to negative (-) terminal on battery.

SAFETY PRECAUTIONS WHILE CHARGING

- An explosive hydrogen gas is discharged through vent holes in the battery during the charging process. Do not allow spark or open flame around the generator or battery during the charging process.
- Electrolyte fluid can burn eyes and clothing. Be extremely careful to avoid contact. If injured, wash the affected area immediately with large quantities of water and consult a doctor for treatment.
- When charging a large capacity battery or totally discharged battery, excessive current may force the DC breaker to turn off. In such cases, use a battery charger to charge a large battery with AC output.
- Battery defects may cause the DC breaker to turn off. Check the battery before replacing the DC breaker.

3. STOPPING THE GENERATOR

- (a) Turn off the power switch of the electric equipment and unplug the cord from receptacle of the generator.
- (b) Allow the engine about 3 minutes to cool down at no load before stopping.
- (c) Turn the engine switch to the position "  " (STOP). (See Fig. 4-6)

4. OIL SENSOR (See Fig. 4-7)

- (a) The oil sensor detects the fall in oil level in the crankcase and automatically stops the engine when the oil level falls below a predetermined level.
- (b) When engine has stopped automatically, switch off generator's AC circuit breaker, and check the oil level.
Refill engine oil to the upper level as instructed on page 6 and restart the engine.
- (c) If the engine dose not start by usual starting procedures, check the oil level

❶ OIL SENSOR

CAUTION

**Do not remove OIL SENSOR PROBE when refilling with oil.
Remove oil filler cap on the opposite side of carburetor.**

6. WATTAGE INFORMATION

Some appliances need a "surge" of energy when starting.

This means that the amount of electrical power needed to start the appliance may exceed the amount needed to maintain its use.

Electrical appliances and tools normally come with a label indicating voltage, cycles / Hz, amperage (amps) and electrical power needed to run the appliance or tool.

Check with your nearest dealer or service center with questions regarding power surge of certain appliances or power tools.

- Electrical loads such as incandescent lamps and hot plates require the same wattage to start as is needed to maintain use.
- Loads such as fluorescent lamps require 1.2 to 2 times the indicated wattage during start-up.
- Loads for mercury lamps require 2 to 3 times the indicated wattage during start-up.
- Electrical motors require a large starting current. Power requirements depend on the type of motor and its use. Once enough "surge" is attained to start the motor, the appliance will require only 50% to 30% of the wattage to continue running.
- Most electrical tools require 1.2 to 3 times their wattage for running under load during use. For example, a 5000 watt generator can power a 1800 to 4000 watt electrical tool.
- Loads such as submersible pumps and air compressors require a very large force to start. They need 3 to 5 times the normal running wattage in order to start.
For example, a 5000 watt generator would only be able to drive a 1000 to 1700 watt pump.

NOTE

The following wattage chart is general guide only. Refer to your specific appliance for correct wattage.

To determine the total wattage required to run a particular electrical appliance or tool, multiply the voltage figure of the appliance/tool by the amperage (amps) figure of same. The voltage and amperage (amps) information can be found on a name plate which is normally attached to electrical appliances and tools.

Applications	Applicable Wattage (approx. W)
	50 Hz
Incandescent lamp, Heater	1350
Fluorescent lamp, Electric tool	700
Mercury lamp	400
Pump, Compressor	300

VOLTAGE DROP IN ELECTRIC EXTENSION CORDS

When a long electric extension cord is used to connect an appliance or tool to the generator, a certain amount of voltage drop or loss occurs in the extension cord which reduces the effective voltage available for the appliance or tool. The chart below has been prepared to illustrate the approximate voltage loss when an extension cord of 300 feet (approx. 100 meters) is used to connect an appliance or tool to the generator.

Nominal cross section	A.W.G.	Allowable current	No. of strands / strands dia.	Resistance	Current Amp.							Voltage drop
					1A	3A	5A	8A	10A	12A	15A	
mm ²	No.	A	No./mm	Ω/100m	1A	3A	5A	8A	10A	12A	15A	
0.75	18	7	30/0.18	2.477	2.5V	8V	12.5V	—	—	—	—	
1.27	16	12	50/0.16	1.486	1.5V	5V	7.5V	12V	15V	18V	—	
2.0	14	17	37/0.26	0.952	1V	3V	5V	8V	10V	12V	15V	
3.5	12 to 10	23	45/0.32	0.517	—	1.5V	2.5V	4V	5V	6.5V	7.5V	
5.5	10 to 8	35	70/0.32	0.332	—	1V	2V	2.5V	3.5V	4V	5V	

7. MAINTENANCE SCHEDULE

DAILY	<ul style="list-style-type: none"> ■ Check oil level. ■ Check all components according to "PRE-OPERATION CHECKS."
EVERY 50 HOURS	<ul style="list-style-type: none"> ■ Wash cleaner element. -more often if used in dirty or dusty environments. ■ Check spark plug, clean if necessary.
EVERY 100 HOURS	<ul style="list-style-type: none"> ■ Change engine oil. *-more often if used in dusty or dirty environments.
EVERY 200 HOURS	<ul style="list-style-type: none"> ■ Adjust spark plug gap. ■ Clean fuel strainer. ■ Replace air cleaner element
EVERY 500 HOURS	<ul style="list-style-type: none"> ■ Replace spark plug and cleaner element. ■ Clean and adjust carburetor, valve clearance, and valve seat along with cylinder head.
EVERY 1,000 HOURS (24 MONTHS)	<ul style="list-style-type: none"> ■ Inspect control panel parts. ■ Check rotor and starter. ■ Replace engine mount rubber. ■ Overhaul engine. ■ Change fuel lines.

NOTE : (*)

- Initial oil change should be performed after first twenty (20) hours of use. Thereafter change oil every 100 hours.
- Before changing the oil, check for a suitable way to dispose of the old oil. Do not pour it down sewage drains, onto garden soil or into open streams. Your local zoning or environmental regulations will give you more detailed instructions on proper disposal.



8. "HOW-TO" MAINTENANCE

(See Fig. 5)

⚠ CAUTION

Make sure the engine is stopped before starting any maintenance, servicing or repair.

NOTE

It is recommended to use ear protection when performing operation, maintenance and repair of the generator set.

1. ENGINE OIL CHANGE (See Fig. 5-①)

① OIL DRAIN PLUG

- Change engine oil every 50 hours.
(For new engine, change oil after 20 hours.)
- (a) Drain oil by removing the drain plug and the oil filler cap while the engine is warm.
- (b) Reinstall the drain plug and fill the engine with oil until it reaches the upper level on the oil filler cap.
- Use fresh and high quality lubricating oil to the specified level as directed on page 6.
If contaminated or deteriorated oil is used or the quantity of the engine oil is not sufficient, the engine damage will result and its life will be greatly shortened.

2. SERVICING THE AIR CLEANER (See Fig. 5-②)

Maintaining an air cleaner in proper condition is very important.

Dirt induced through improperly installed, improperly serviced or inadequate elements damages and wears out engines. Keep the element always clean.

- (a) Unhook the cover and remove the cleaner element.

① ELEMENT

② AIR CLEANER COVER

- (b) Paper element: Clean by tapping gently to remove dirt and blow off dust. Never use oil. Clean paper element every 50 hours of operation, and replace element every 200 hours or once a year.
- (c) Urethane form : Wash the element with fresh water. Squeeze out the water then dry the element. (Do not twist.)

3. CLEANING AND ADJUSTING SPARK PLUG (See Fig. 5-③,④)

① SPARK PLUG

② PLUG WRENCH

- (a) If the plug is contaminated with carbon, remove it using a plug cleaner or wire brush.
- (b) Adjust the electrode gap to 0.6 to 0.7 mm.

Spark plug : BMR4A (NGK)

When replacing with new spark plug, use the above-recommended one.

If not available by all means, make sure to replace with equivalent one of resistance type.

4. SPARK ARRESTR

The spark arrester must be cleaned regularly to keep it functioning as designed.

A clogged spark arrester :

- Prevents the flow of exhaust gas
- Reduces engine output
- Increases fuel consumption
- Makes starting difficult

If the engine has been running, the muffler and the spark arrester will be very hot. Allow the muffler to cool before cleaning the spark arrester.

How to remove the spark arrester

- (a) Remove the flange bolts from the muffler cover and remove the muffler cover.
- (b) Remove the special screw from the spark arrester and remove the spark arrester from the muffler.

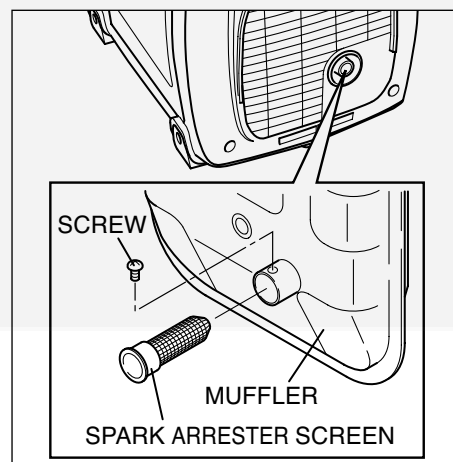

Clean the spark arrester screen

Use a brush to remove carbon deposits from the spark arrester screen.

Be careful to avoid damaging the screen.

The spark arrester must be free of breaks and holes. Replace the spark arrester if it is damaged.

Install the spark arrester, and muffler protector in the reverse order of disassembly.



9. PERIODIC OPERATION AND INSPECTION

When furnishing the generator as emergency electric power source, periodic operation and inspection are needed.

Fuel (gasoline) and engine oil will be deteriorated with time, and this causes that the engine is difficult to start and as the results improper engine operation and fault.

CAUTION

Since the fuel (gasoline) will be deteriorated with time, replace fuel (gasoline) with fresh one periodically; once every three (3) months is recommended.

- Check the fuel (gasoline), engine oil and air cleaner.
- Start engine.
- With appliance such as lightings activated, run the engine for over ten minutes.
- Check for the following items;
 - Proper engine running.
 - Adequate output and the indicator lamp turned on properly.
 - The engine switch normally operated.
 - No leakage of engine oil and fuel (gasoline).

10. TRANSPORTING

When transporting the generator, make sure that the fuel (gasoline) should be drained from the tank.

WARNING

- To prevent fuel spillage due to the vibration and impact, never transport the generator with the fuel (gasoline) filled in the tank.
- Secure the tank cap thoroughly.
- To avoid the risk of the gasoline flammability, never leave the generator in an area exposed to direct sunlight or high temperatures for a long time.
- Keep the fuel (gasoline) in the exclusive gasoline storage tank made by steel when transporting.

- Turn the engine switch to the "STOP" position.

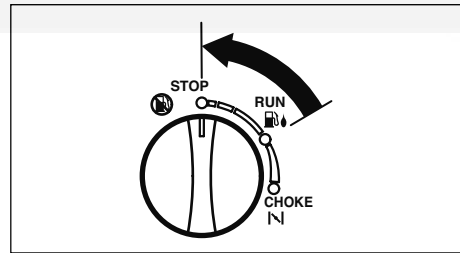

- Drain the fuel from the tank.
- Secure the tank cap and set the cover in position.



CAUTION

- Do not place any heavy objects on the generator.
- Select and place the generator in the proper position of the transport vehicle so that the generator not be moved or fallen down. Fix the generator with rope as necessary.

11. PREPARATION FOR STORAGE (See Fig. 6)

The following procedures should be followed prior to storage of your generator for periods of 6 months or longer.

- Drain fuel from fuel tank carefully by disconnecting the fuel line.
Gasoline left in the fuel tank will eventually deteriorate making engine-starting difficult.
- When draining fuel from the fuel tank, use the hand pump and set it into the refilling port. (See Fig. 6-1)
- Remove the drain screw of the carburetor. (See Fig. 6-2)
 - ① DRAIN SCREW
- Change engine oil.
- Check for loose bolts and screws, tighten them if necessary.
- Clean generator thoroughly with oiled cloth. Spray with preservative if available. NEVER USE WATER TO CLEAN GENERATOR !
- Pull starter handle until resistance is felt, leaving handle in that position.
- Store generator in a well ventilated, low humidity area.

12. TROUBLESHOOTING

When generator engine fails to start after several attempts, or if no electricity is available at the output socket, check the following chart. If your generator still fails to start or generate electricity, contact your nearest Cummins dealer or service shop for further information or corrective procedures.

When Engine Fails to Start:

Check if engine switch is in its proper position.	↔	Turn engine switch to "N" (CHOKE) position.
Check fuel level.	↔	If empty, refill fuel tank making sure not to overfill.
Check to make sure generator is not connected to an appliance.		If connected, turn off the power switch on the connected appliance and unplug.
Check spark plug for loose spark plug cap.		If loose, push spark plug cap back into place.
Check spark plug for contamination.		Remove spark plug and clean electrode.
Check if the recommended spark plug would be adopted.	↔	If not, replace with the recommended spark plug. If the recommended spark plug is not available by all means, make sure to replace with equivalent one of resistance type.
Check engine oil level.		If the engine oil level is low, add the oil to the upper level line on the oil gauge.

When No Electricity Is Generated at Receptacle:

Check if the Overload Lamp is turned ON (Red).	↔	Stop the engine and check the appliances and/or generator for overloading.
Check if the DC circuit breaker is turned OFF.		Depress the circuit breaker into ON position, after making sure the electric appliances are in the normal condition.
Check AC receptacle and DC terminals for loose connection.		Secure connection if necessary.
Check to see if engine starting was attempted with appliances already connected to generator.	↔	Turn off switch on the appliance, and disconnect cable from receptacle. Reconnect after generator has been started properly.

13. SPECIFICATIONS

MODEL		P1700i
Generator	Type	Multipole revolving field INVERTER type
	AC Output	
	Rated Frequency Hz	50
	Rated voltage V	240
	Rated current A	5.6
	Maximum output kVA	1.65
	Rated output kVA	1.35
	Rated power factor	1.0
	Safety device ; type	Electoronic
	DC Output	
	Rated voltage V	12
Rated current A	8.3	
Safety device ; type	Current breaker	
Ground system	Neutral floating	
Engine	Model	EH09-2
	Type	Forced air-cooled,4-cycle,single cylinder OHV type gasoline engine
	Displacement mL	85.8
	Fuel	Automobil unleaded gasoline
	Fuel tank capacity L	3.5
	Rated continuous operation [Approx.] hours	3.5
	Engine oil capacity L	0.4
	Spark plug	BMR4A (NGK)
	Starting system	Recoil starter
	Dimension	Length mm
Width mm		295
Height mm		445
Dry weight kg		20.5

NOTE ; Specifications are subject to change without notice.

14.WIRING DIAGRAM

P1700i (50Hz-240V)

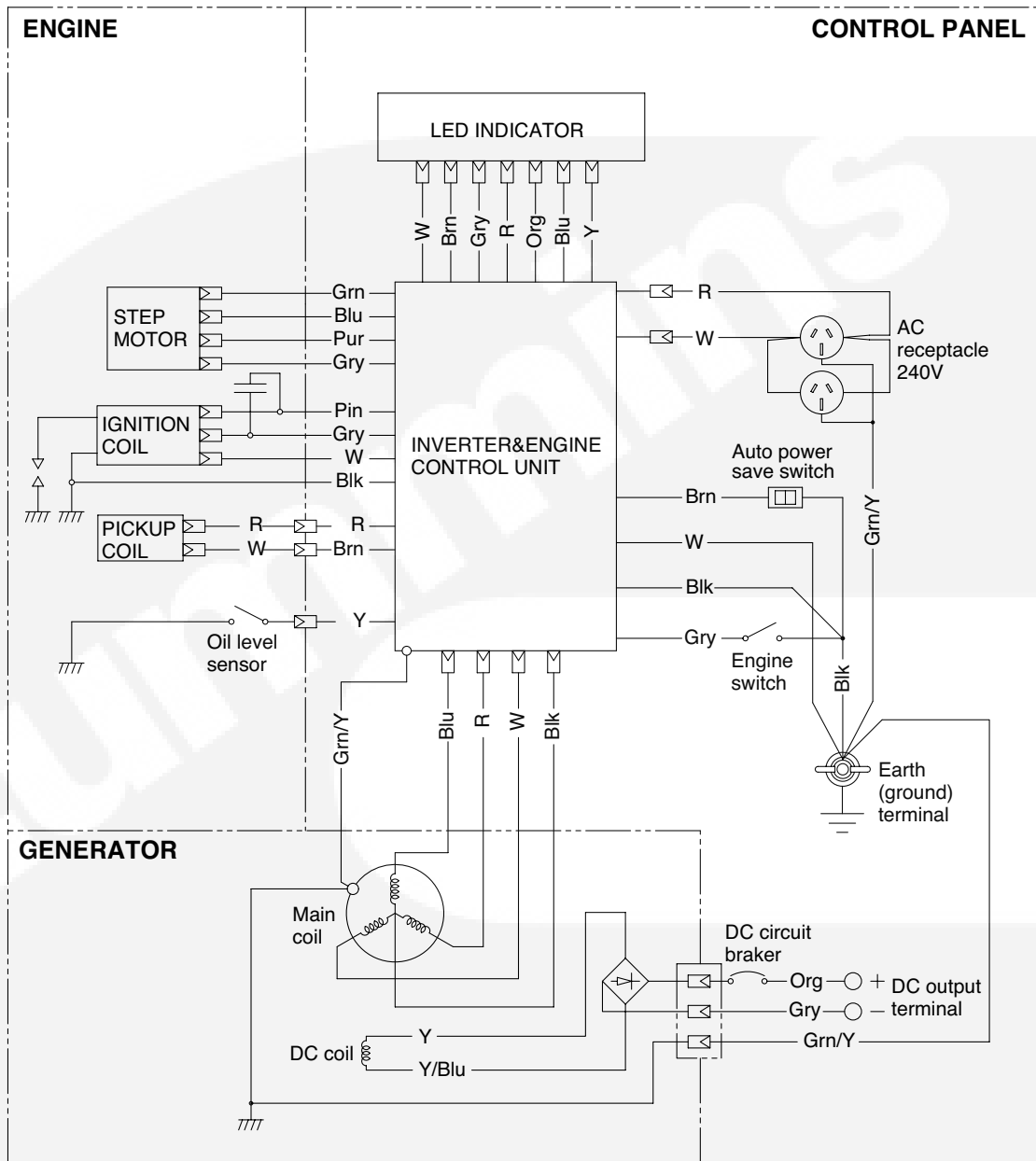

Wiring color code

Blk : Black Pin : Pink Grn : Green Gry : Gray Y : Yellow Pur : Purple
 Brn : Brown R : Red Blu : Blue Org : Orange W : White Grn/Y : Green/Yellow

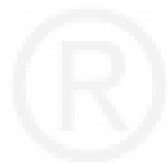

Cummins

Cummins **Onan**

Cummins Power Generation

1400 73rd Ave. NE
Minneapolis, MN 55432 USA

Phone 1 763 574 5000

Toll-free 1 800 888 6626

Fax 1 763 574 5298

Email www.cumminsonan.com/contact

www.cumminsonan.com

Cummins®, Onan®, the "C" logo, and "Performance you rely on." are trademarks of Cummins Inc.

©2008 Cummins Power Generation, Inc. All rights reserved.

